

NPN MEDIUM POWER TRANSISTOR

Features

- HIGH CURRENT
- LOW SATURATION VOLTAGE
- COMPLEMENT TO 2SB772

Applications

- VOLTAGE REGULATION
- RELAY DRIVER
- GENERIC SWITCH
- AUDIO POWER AMPLIFIER
- DC-DC CONVERTER

Description

The device is a NPN transistor manufactured by using planar Technology resulting in rugged high performance devices. The complementary PNP type is 2SB772.

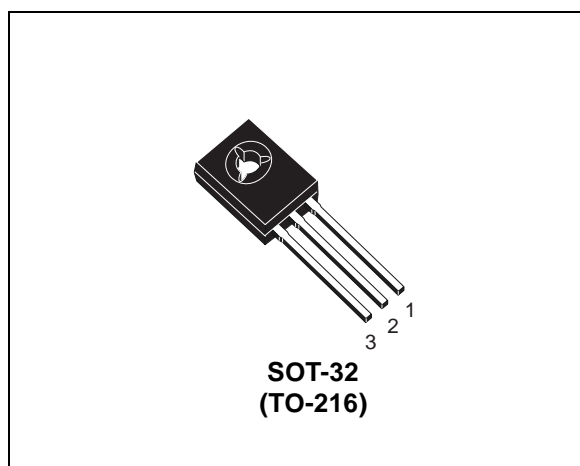

Internal Schematic Diagram

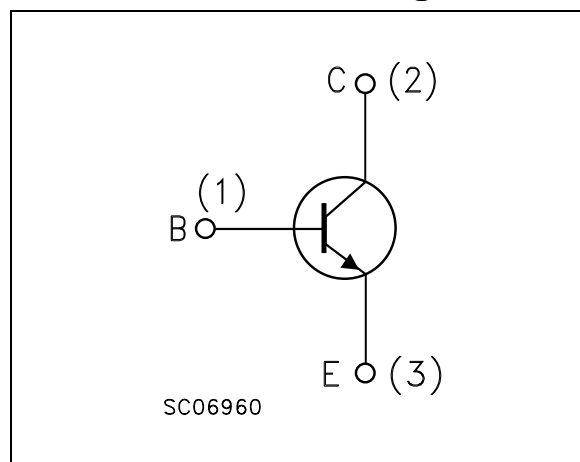

Order Codes

Part Number	Marking	Package	Packing
2SD882	D882	SOT-32	TUBE

1 Absolute Maximum Ratings

Table 1. Absolute Maximum Rating

Symbol	Parameter	Value	Unit
V_{CBO}	Collector-Base Voltage ($I_E = 0$)	60	V
V_{CEO}	Collector-Emitter Voltage ($I_B = 0$)	30	V
V_{EBO}	Collector-Base Voltage ($I_C = 0$)	5	V
I_C	Collector Current	3	A
I_{CM}	Collector Peak Current ($t_p < 5ms$)	6	A
I_B	Base Current	1	A
I_{BM}	Base Peak Current ($t_p < 5ms$)	2	A
P_{TOT}	Total dissipation at $T_c = 25^\circ C$	12.5	W
T_{STG}	Storage Temperature	-65 to 150	$^\circ C$
T_J	Max. Operating Junction Temperature	150	$^\circ C$

Table 2. Thermal Data

Symbol	Parameter	Value	Unit
$R_{thJ-case}$	Thermal Resistance Junction-Case Max	10	$^\circ C/W$

2 Electrical Characteristics

Table 3. Electrical Characteristics ($T_{CASE} = 25^{\circ}C$; unless otherwise specified)

Symbol	Parameter	Test Conditions	Min.	Typ.	Max.	Unit
I_{CES}	Collector Cut-off Current ($V_{BE} = 0$)	$V_{CE} = 60\text{ V}$			10	μA
I_{CEO}	Collector Cut-off Current ($I_B = 0$)	$V_{CE} = 30\text{ V}$			100	μA
I_{EBO}	Emitter Cut-off Current ($I_C = 0$)	$V_{EB} = 5\text{ V}$			10	μA
$V_{(BR)CEO}$ <i>Note: 1</i>	Collector-Emitter Breakdown Voltage ($I_B = 0$)	$I_C = 10\text{ mA}$	30			V
$V_{(BR)CBO}$	Collector-Base Breakdown Voltage ($I_E = 0$)	$I_C = 100\ \mu\text{A}$	60			V
$V_{(BR)EBO}$	Emitter-Base Breakdown Voltage ($I_C = 0$)	$I_E = 100\ \mu\text{A}$	5			V
$V_{CE(sat)}$ <i>Note: 1</i>	Collector-Emitter Saturation Voltage	$I_C = 1\text{ A}$ $I_B = 50\text{ mA}$ $I_C = 2\text{ A}$ $I_B = 100\text{ mA}$ $I_C = 3\text{ A}$ $I_B = 150\text{ mA}$			0.4 0.7 1.1	V V V
$V_{BE(sat)}$ <i>Note: 1</i>	Base-Emitter Saturation Voltage	$I_C = 2\text{ A}$ $I_B = 100\text{ mA}$			1.2	V
hFE	DC Current Gain	$I_C = 100\text{ mA}$ $V_{CE} = 2\text{ V}$ $I_C = 1\text{ A}$ $V_{CE} = 2\text{ V}$ $I_C = 3\text{ A}$ $V_{CE} = 2\text{ V}$	100 80 30		300	
fT	Transition Frequency	$I_C = 0.1\text{ A}$ $V_{CE} = 10\text{ V}$		100		MHz

Note: 1 Pulsed duration = 300 μs , duty cycle $\leq 1.5\%$.

2.1 Typical characteristics

Figure 1. Reverse biased area

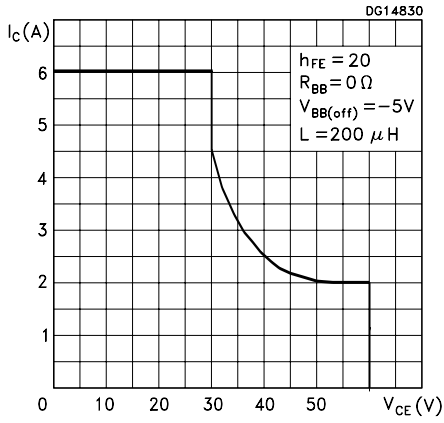

Figure 2. DC current gain

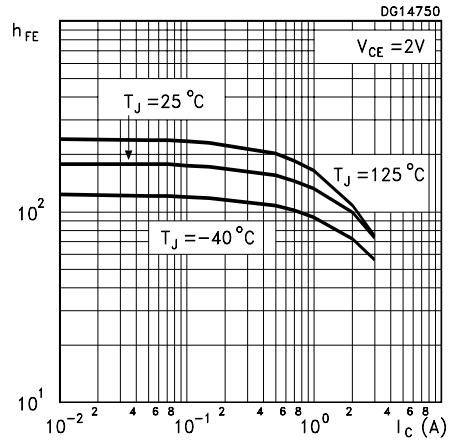
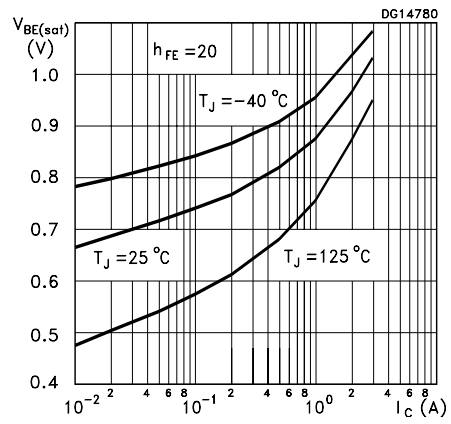
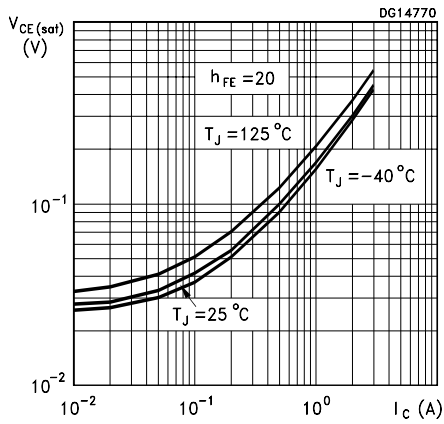

Figure 3. Collector-emitter saturation voltage Figure 4. Base-emitter saturation voltage



3 Package Mechanical Data

In order to meet environmental requirements, ST offers these devices in ECOPACK® packages. These packages have a Lead-free second level interconnect . The category of second level interconnect is marked on the package and on the inner box label, in compliance with JEDEC Standard JESD97. The maximum ratings related to soldering conditions are also marked on the inner box label. ECOPACK is an ST trademark. ECOPACK specifications are available at: www.st.com

SOT-32 (TO-126) MECHANICAL DATA

DIM.	mm			inch		
	MIN.	TYP.	MAX.	MIN.	TYP.	MAX.
A	7.4		7.8	0.291		0.307
B	10.5		10.8	0.413		0.445
b	0.7		0.9	0.028		0.035
b1	0.49		0.75	0.019		0.030
C	2.4		2.7	0.040		0.106
c1	1.0		1.3	0.039		0.050
D	15.4		16.0	0.606		0.629
e		2.2			0.087	
e3	4.15		4.65	0.163		0.183
F		3.8			0.150	
G	3		3.2	0.118		0.126
H			2.54			0.100
H2		2.15			0.084	

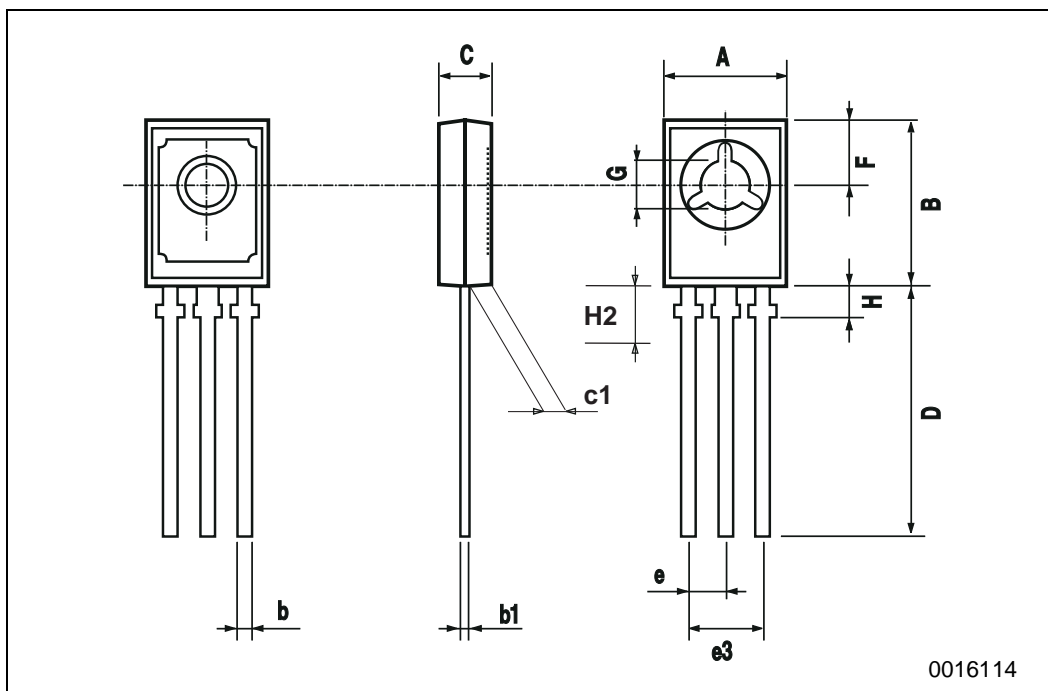

4 Revision History

Date	Revision	Changes
09-Sep-2005	2	Final datasheet. New template

Information furnished is believed to be accurate and reliable. However, STMicroelectronics assumes no responsibility for the consequences of use of such information nor for any infringement of patents or other rights of third parties which may result from its use. No license is granted by implication or otherwise under any patent or patent rights of STMicroelectronics. Specifications mentioned in this publication are subject to change without notice. This publication supersedes and replaces all information previously supplied. STMicroelectronics products are not authorized for use as critical components in life support devices or systems without express written approval of STMicroelectronics.

The ST logo is a registered trademark of STMicroelectronics.
All other names are the property of their respective owners

© 2005 STMicroelectronics - All rights reserved

STMicroelectronics group of companies

Australia - Belgium - Brazil - Canada - China - Czech Republic - Finland - France - Germany - Hong Kong - India - Israel - Italy - Japan -
Malaysia - Malta - Morocco - Singapore - Spain - Sweden - Switzerland - United Kingdom - United States of America

www.st.com

