

Features

- AEC Q100 Qualified
- 4A Peak Source/Sink Drive Current
- Wide Operating Voltage Range: 4.5V to 35V
- AEC Q100 Grade 1 -40°C to +125°C Operating Temperature Range
- Logic Input Withstands Negative Swing of up to 5V
- Outputs May be Connected in Parallel for Higher Drive Current
- Matched Rise and Fall Times
- Low Propagation Delay Time
- Low, 10µA Supply Current
- Low Output Impedance

Features

- Automotive DC/DC regulators
- Electronic Power Steering
- Electric Vehicle Power Train Drives
- Brushless DC motors





Description

The IXD_604SI and IXD_604SIA are automotive grade, dual high-speed gate drivers that are qualified according to AEC Q100 standards. Each of the two outputs can source and sink 4A of peak current, while producing rise and fall times of less than 10ns. The outputs and inputs are rated to 35V. The input of each driver is virtually immune to latch-up, and proprietary circuitry eliminates cross-conduction and "shoot-through." The IXD_604 has a Grade 1, -40°C to +125°C ambient operating temperature range.

The IXDD604 is a dual non-inverting driver with an enable. The IXDN604 is a dual non-inverting driver, the IXDI604 is a dual inverting driver, and the IXDF604 has one inverting driver and one non-inverting driver. The AEC Q100 qualified IXD_604SIA is available in a standard 8-pin SOIC package, and the IXD_604SI is available in an 8-pin Power SOIC package with an exposed metal back.

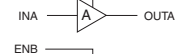
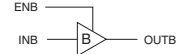
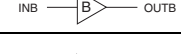
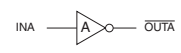
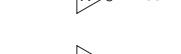
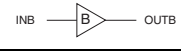

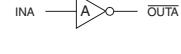
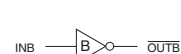
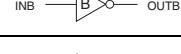
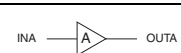
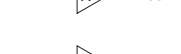
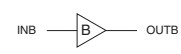
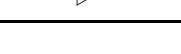
Ordering Information

| Part Number | Logic Configuration | Package Type | Packing Method | Quantity |
|--------------|---|--|----------------|----------|
| IXDD604SI |  | 8-Pin Power SOIC with Exposed Metal Back | Tube | 100 |
| IXDD604SITR |  | 8-Pin Power SOIC with Exposed Metal Back | Tape & Reel | 2000 |
| IXDD604SIA |  | 8-Pin SOIC | Tube | 100 |
| IXDD604SIATR |  | 8-Pin SOIC | Tape & Reel | 2000 |
| IXDF604SI |  | 8-Pin Power SOIC with Exposed Metal Back | Tube | 100 |
| IXDF604SITR |  | 8-Pin Power SOIC with Exposed Metal Back | Tape & Reel | 2000 |
| IXDF604SIA |  | 8-Pin SOIC | Tube | 100 |
| IXDF604SIATR |  | 8-Pin SOIC | Tape & Reel | 2000 |
| IXDI604SI |  | 8-Pin Power SOIC with Exposed Metal Back | Tube | 100 |
| IXDI604SITR |  | 8-Pin Power SOIC with Exposed Metal Back | Tape & Reel | 2000 |
| IXDI604SIA |  | 8-Pin SOIC | Tube | 100 |
| IXDI604SIATR |  | 8-Pin SOIC | Tape & Reel | 2000 |
| IXDN604SI |  | 8-Pin Power SOIC with Exposed Metal Back | Tube | 100 |
| IXDN604SITR |  | 8-Pin Power SOIC with Exposed Metal Back | Tape & Reel | 2000 |
| IXDN604SIA |  | 8-Pin SOIC | Tube | 100 |
| IXDN604SIATR |  | 8-Pin SOIC | Tape & Reel | 2000 |

| | |
|--|-----------|
| 1. Specifications | 3 |
| 1.1 Pin Configurations | 3 |
| 1.2 Pin Definitions | 3 |
| 1.3 Absolute Maximum Ratings | 3 |
| 1.4 Recommended Operating Conditions | 3 |
| 1.5 Electrical Characteristics: $T_A = 25^\circ\text{C}$ | 4 |
| 1.6 Electrical Characteristics: $-40^\circ\text{C} \leq T_A \leq +125^\circ\text{C}$ | 4 |
| 1.7 Thermal Characteristics | 5 |
| 2. IXD_604 Performance | 5 |
| 2.1 Timing Diagrams | 5 |
| 2.2 Characteristics Test Diagram | 5 |
| 3. Block Diagrams & Truth Tables | 6 |
| 3.1 IXDD604 | 6 |
| 3.2 IXDI604 | 6 |
| 3.3 IXDF604 | 6 |
| 3.4 IXDN604 | 6 |
| 4. Typical Performance Characteristics | 7 |
| 5. Manufacturing Information | 10 |
| 5.1 Moisture Sensitivity | 10 |
| 5.2 ESD Sensitivity | 10 |
| 5.3 Reflow Profile | 10 |
| 5.4 Mechanical Dimensions | 11 |

1 Specifications

1.1 Pin Configurations

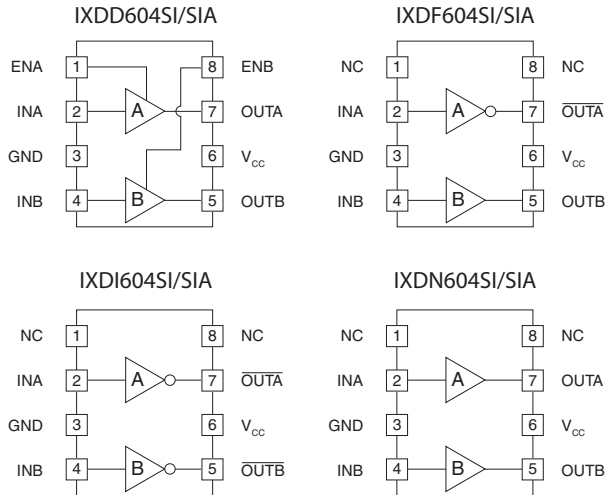

1.2 Pin Definitions

| Pin Name | Description |
|-----------------|--|
| INA | Channel A Logic Input |
| INB | Channel B Logic Input |
| ENA | Channel A Enable Input - Drive pin low to disable Channel A and force Channel A Output to a high impedance state |
| ENB | Channel B Enable Input - Drive pin low to disable Channel A and force Channel A Output to a high impedance state |
| OUTA OUTA | Channel A Output - Sources or sinks current to turn-on or turn-off a discrete MOSFET or IGBT |
| OUTB OUTB | Channel B Output - Sources or sinks current to turn-on or turn-off a discrete MOSFET or IGBT |
| V _{CC} | Supply Voltage - Provides power to the device |
| GND | Ground - Common ground reference for the device |

1.3 Absolute Maximum Ratings

| Parameter | Symbol | Minimum | Maximum | Units |
|----------------------|-------------------------------------|---------|----------------------|-------|
| Supply Voltage | V _{CC} | -0.3 | 40 | V |
| Input Voltage | V _{INx} , V _{ENx} | -5 | V _{CC} +0.3 | V |
| Output Current | I _{OUT} | - | ±4 | A |
| Junction Temperature | T _J | -55 | +150 | °C |
| Storage Temperature | T _{STG} | -65 | +150 | °C |

Absolute maximum electrical ratings are at 25°C

Absolute maximum ratings are stress ratings. Stresses in excess of these ratings can cause permanent damage to the device. Functional operation of the device at conditions beyond those indicated in the operational sections of this data sheet is not implied.

1.4 Recommended Operating Conditions

| Parameter | Symbol | Range | Units |
|-----------------------------|-----------------|-------------|-------|
| Supply Voltage | V _{CC} | 4.5 to 35 | V |
| Operating Temperature Range | T _A | -40 to +125 | °C |

1.5 Electrical Characteristics: $T_A = 25^\circ\text{C}$

 Test Conditions: $4.5\text{V} \leq V_{CC} \leq 35\text{V}$, one channel (unless otherwise noted).

| Parameter | Conditions | Symbol | Minimum | Typical | Maximum | Units | |
|--|---|--------------|----------------|---------|-------------|---------------|------------------|
| Input Voltage, High | $4.5\text{V} \leq V_{CC} \leq 18\text{V}$ | V_{IH} | 3.0 | - | - | V | |
| Input Voltage, Low | $4.5\text{V} \leq V_{CC} \leq 18\text{V}$ | V_{IL} | - | - | 0.8 | | |
| Input Current | $0\text{V} \leq V_{IN} \leq V_{CC}$ | I_{IN} | - | - | ± 10 | μA | |
| High EN Input Voltage | IXDD604 only | V_{ENH} | $2/3V_{CC}$ | - | - | V | |
| Low EN Input Voltage | IXDD604 only | V_{ENL} | - | - | $1/3V_{CC}$ | | |
| Output Voltage, High | - | V_{OH} | $V_{CC}-0.025$ | - | - | V | |
| Output Voltage, Low | - | V_{OL} | - | - | 0.025 | | |
| Output Resistance, High State | $V_{CC}=18\text{V}, I_{OUT}=-10\text{mA}$ | R_{OH} | - | 1.3 | 2.5 | Ω | |
| Output Resistance, Low State | $V_{CC}=18\text{V}, I_{OUT}=10\text{mA}$ | R_{OL} | - | 1.1 | 2 | | |
| Output Current, Continuous | Limited by package power dissipation | I_{DC} | - | - | ± 1 | A | |
| Rise Time | $V_{CC}=18\text{V}, C_{LOAD}=1000\text{pF}$ | t_r | - | 9 | 16 | ns | |
| Fall Time | $V_{CC}=18\text{V}, C_{LOAD}=1000\text{pF}$ | t_f | - | 8 | 14 | | |
| On-Time Propagation Delay | $V_{CC}=18\text{V}, C_{LOAD}=1000\text{pF}$ | t_{ondly} | - | 29 | 50 | | |
| Off-Time Propagation Delay | $V_{CC}=18\text{V}, C_{LOAD}=1000\text{pF}$ | t_{offdly} | - | 35 | 50 | | |
| Enable to Output-High Delay Time | IXDD604 only, $V_{CC}=18\text{V}$ | t_{ENOH} | - | 35 | 55 | | |
| Disable to High Impedance State Delay Time | IXDD604 only, $V_{CC}=18\text{V}$ | t_{DOLD} | - | 40 | 55 | | |
| Enable Pull-Up Resistor | - | R_{EN} | - | 200 | - | | $\text{k}\Omega$ |
| Power Supply Current | $V_{CC}=18\text{V}, V_{IN}=3.5\text{V}$ | I_{CC} | - | 1 | 3 | | mA |
| | $V_{CC}=18\text{V}, V_{IN}=0\text{V}$ | | - | <1 | 10 | | |
| | $V_{CC}=18\text{V}, V_{IN}=V_{CC}$ | | - | <1 | 10 | μA | |

1.6 Electrical Characteristics: $-40^\circ\text{C} \leq T_A \leq +125^\circ\text{C}$

 Test Conditions: $4.5\text{V} \leq V_{CC} \leq 35\text{V}$, one channel (unless otherwise noted).

| Parameter | Conditions | Symbol | Minimum | Maximum | Units | |
|--|---|--------------|----------------|---------|---------------|----|
| Input Voltage, High | $4.5\text{V} \leq V_{CC} \leq 18\text{V}$ | V_{IH} | 3.3 | - | V | |
| Input Voltage, Low | $4.5\text{V} \leq V_{CC} \leq 18\text{V}$ | V_{IL} | - | 0.65 | | |
| Input Current | $0\text{V} \leq V_{IN} \leq V_{CC}$ | I_{IN} | -10 | 10 | μA | |
| Output Voltage, High | - | V_{OH} | $V_{CC}-0.025$ | - | V | |
| Output Voltage, Low | - | V_{OL} | - | 0.025 | | |
| Output Resistance, High State | $V_{CC}=18\text{V}, I_{OUT}=-10\text{mA}$ | R_{OH} | - | 3 | Ω | |
| Output Resistance, Low State | $V_{CC}=18\text{V}, I_{OUT}=10\text{mA}$ | R_{OL} | - | 2.5 | | |
| Output Current, Continuous | Limited by package power dissipation | I_{DC} | - | ± 1 | A | |
| Rise Time | $V_{CC}=18\text{V}, C_{LOAD}=1000\text{pF}$ | t_r | - | 16 | ns | |
| Fall Time | $V_{CC}=18\text{V}, C_{LOAD}=1000\text{pF}$ | t_f | - | 14 | | |
| On-Time Propagation Delay | $V_{CC}=18\text{V}, C_{LOAD}=1000\text{pF}$ | t_{ondly} | - | 65 | | |
| Off-Time Propagation Delay | $V_{CC}=18\text{V}, C_{LOAD}=1000\text{pF}$ | t_{offdly} | - | 65 | | |
| Enable to Output-High Delay Time | IXDD604 only, $V_{CC}=18\text{V}$ | t_{ENOH} | - | 65 | | |
| Disable to High Impedance State Delay Time | IXDD604 only, $V_{CC}=18\text{V}$ | t_{DOLD} | - | 65 | | |
| Power Supply Current | $V_{CC}=18\text{V}, V_{IN}=3.5\text{V}$ | I_{CC} | - | 3.5 | | mA |
| | $V_{CC}=18\text{V}, V_{IN}=0\text{V}$ | | - | 150 | | |
| | $V_{CC}=18\text{V}, V_{IN}=V_{CC}$ | | - | 150 | μA | |

1.7 Thermal Characteristics

| Package | Parameter | Symbol | Rating | Units |
|-----------------------|---|---------------|--------|-------|
| SI (8-Pin Power SOIC) | Thermal Resistance, Junction-to-Ambient | θ_{JA} | 85 | °C/W |
| SIA (8-Pin SOIC) | | | 120 | |
| SI (8-Pin Power SOIC) | Thermal Resistance, Junction-to-Case | θ_{JC} | 10 | |

2 IXD_604 Performance

2.1 Timing Diagrams

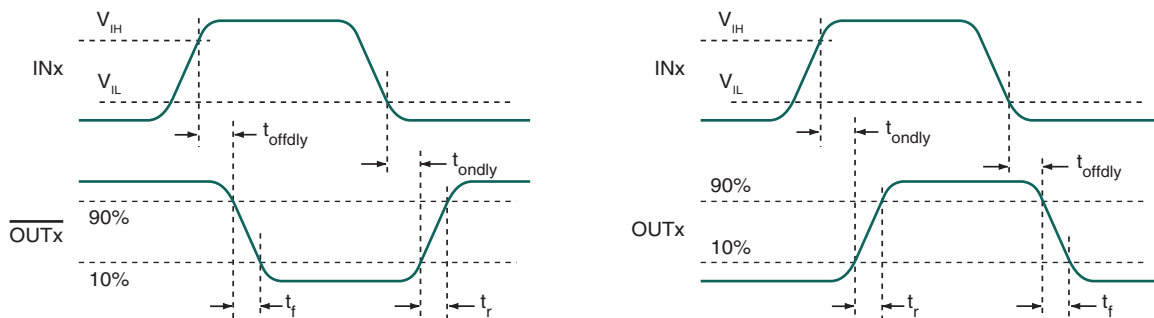

2.2 Characteristics Test Diagram

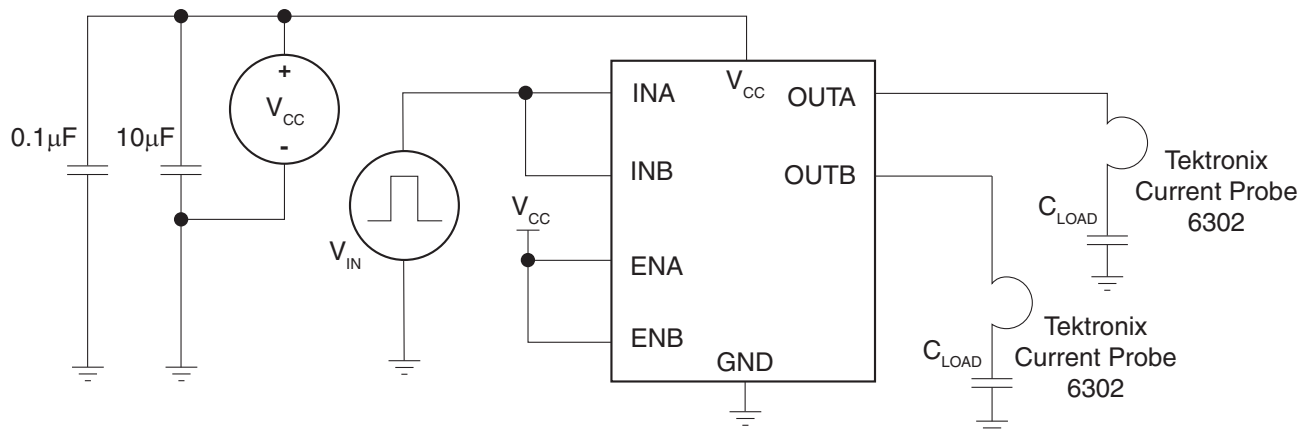

3 Block Diagrams & Truth Tables

3.1 IXDD604

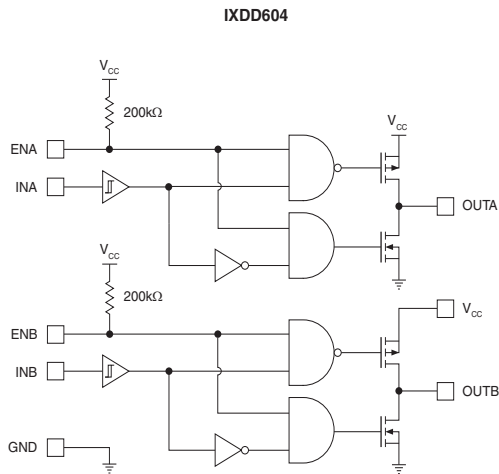

| IN_x | EN_x | OUT_x |
|--------|-----------|---------|
| 0 | 1 or open | 0 |
| 1 | 1 or open | 1 |
| 0 | 0 | Z |
| 1 | 0 | Z |

3.3 IXDF604

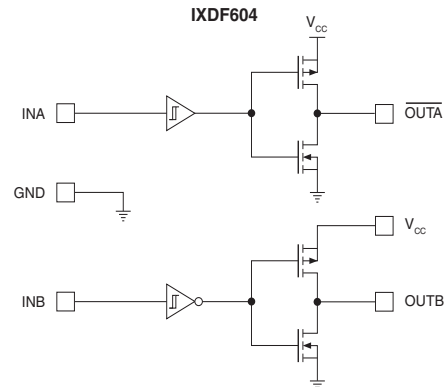

| INA | \overline{OUTA} |
|-------|-------------------|
| 0 | 1 |
| 1 | 0 |
| INB | $OUTB$ |
| 0 | 0 |
| 1 | 1 |

3.2 IXDI604

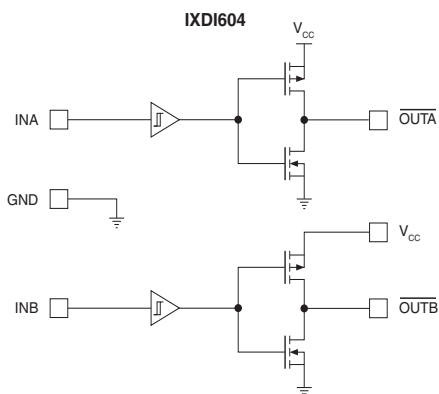

| IN_x | $\overline{OUT_x}$ |
|--------|--------------------|
| 0 | 1 |
| 1 | 0 |

3.4 IXDN604

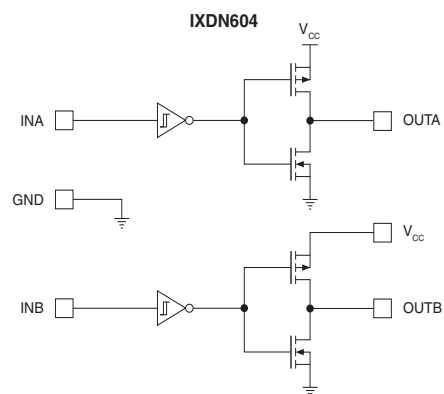

| IN_x | OUT_x |
|--------|---------|
| 0 | 0 |
| 1 | 1 |

4 Typical Performance Characteristics

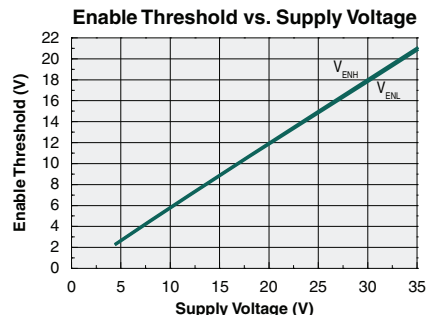
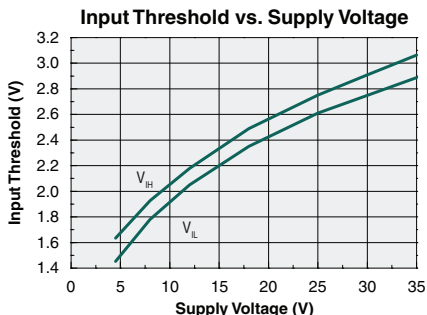
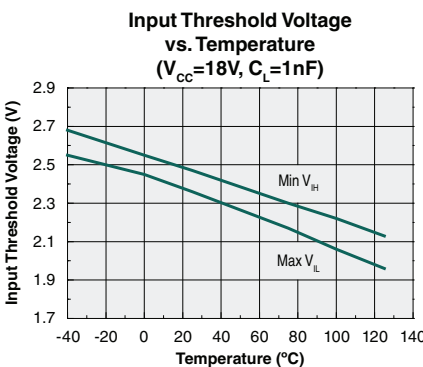
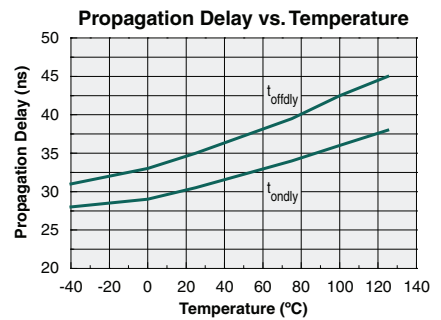
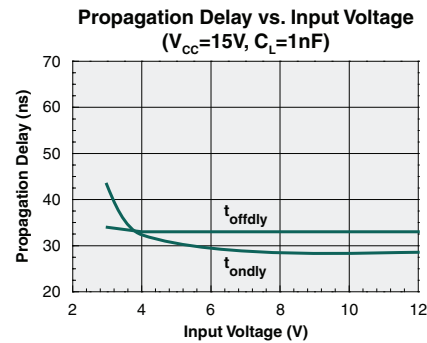
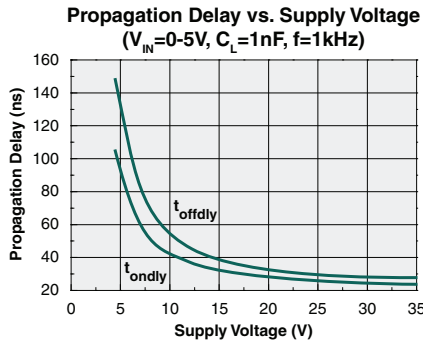
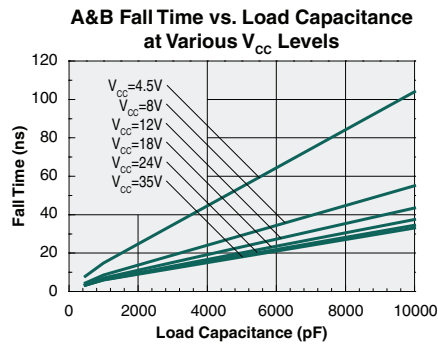
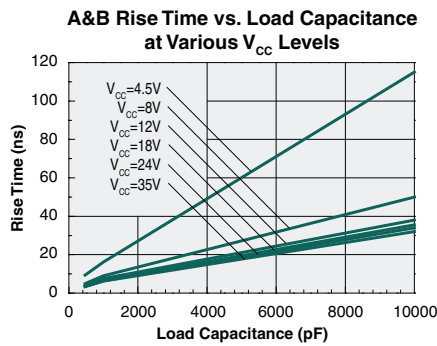
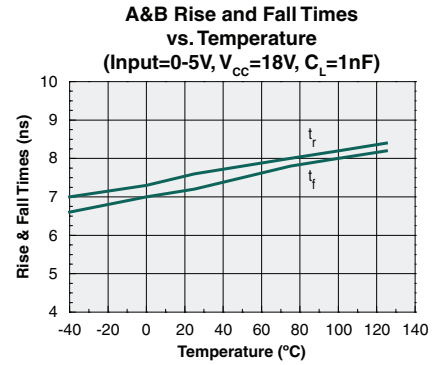
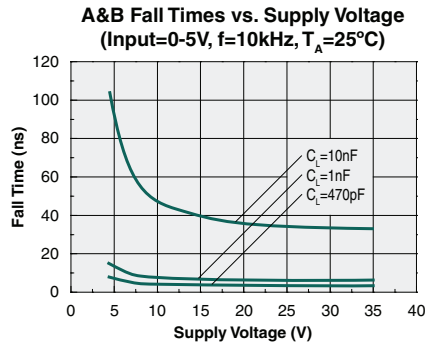
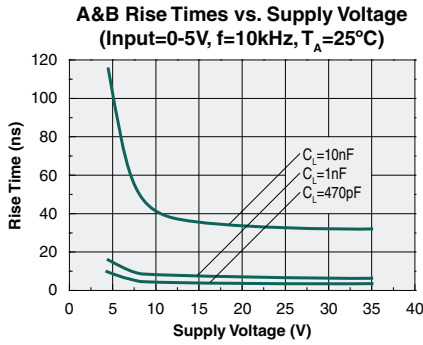

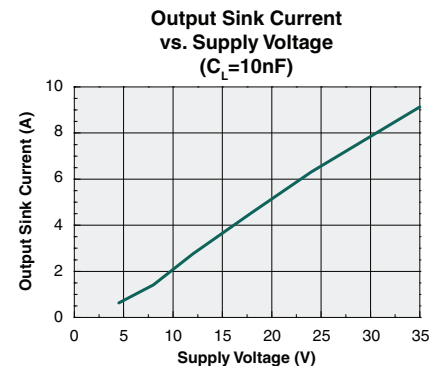
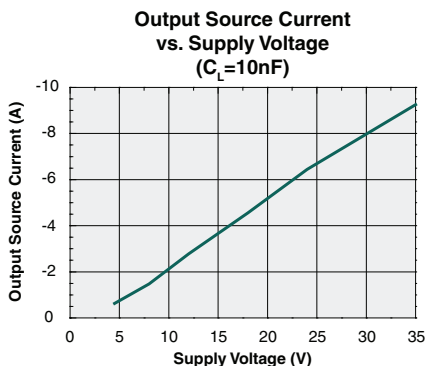
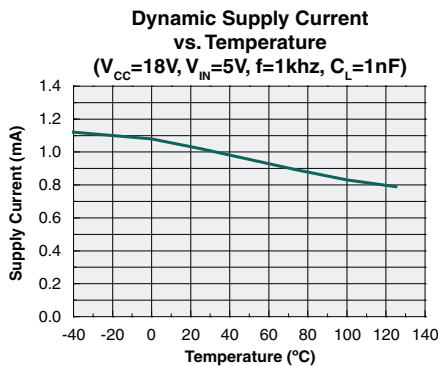
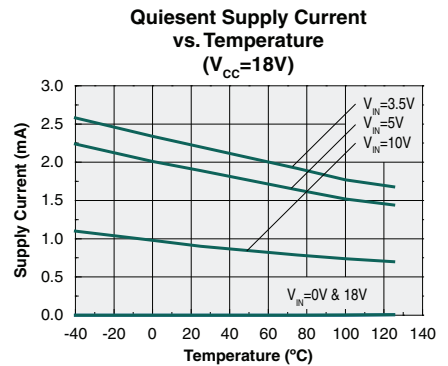
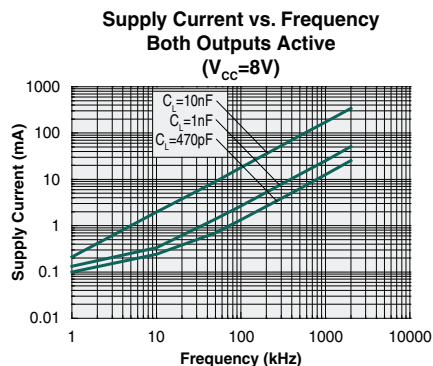
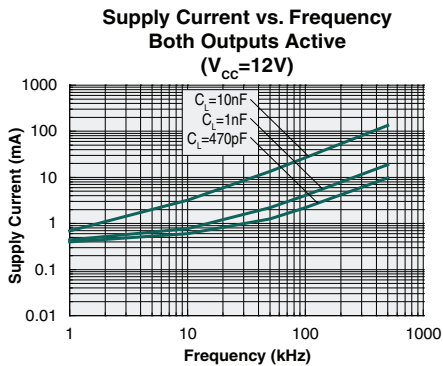
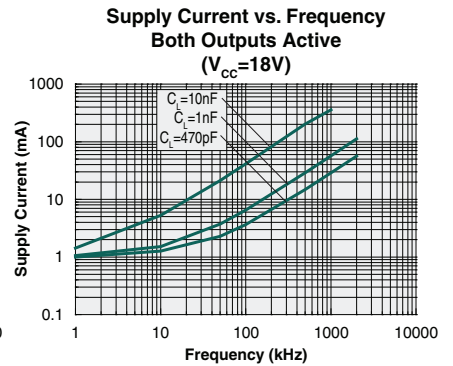
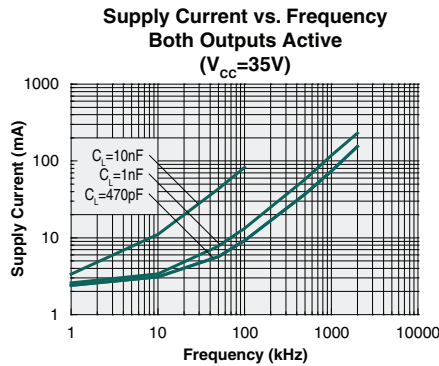
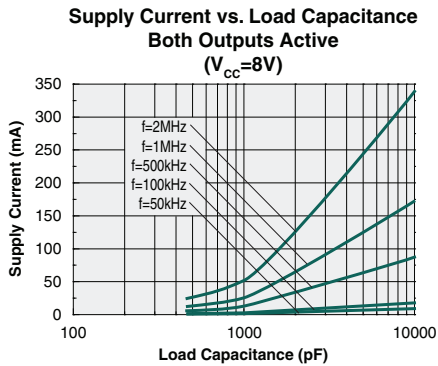
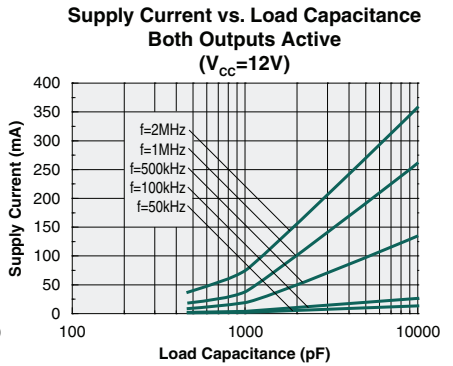
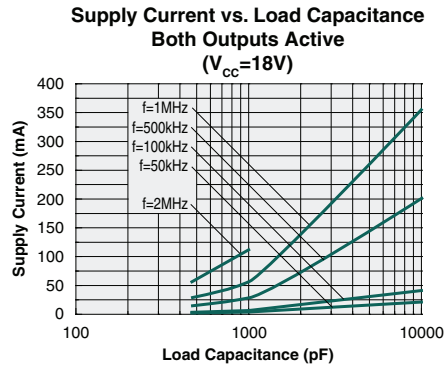
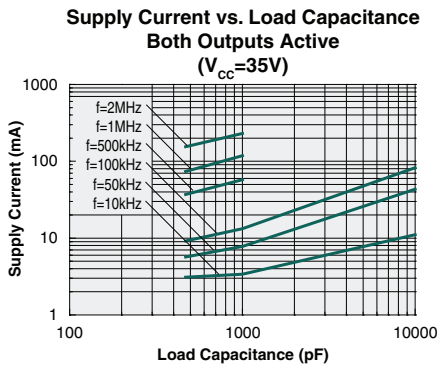

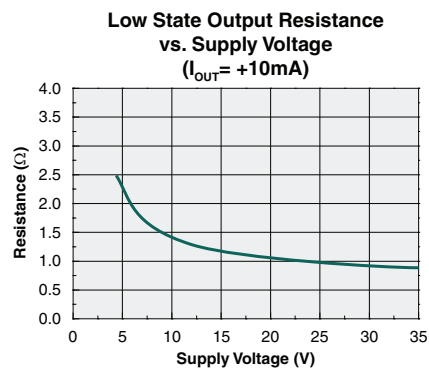
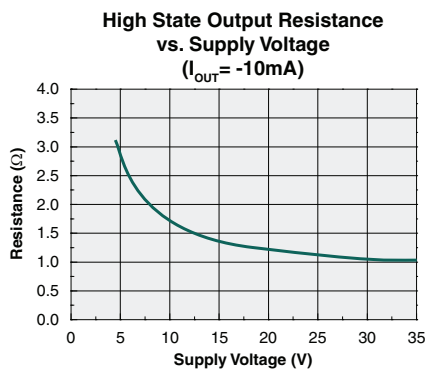
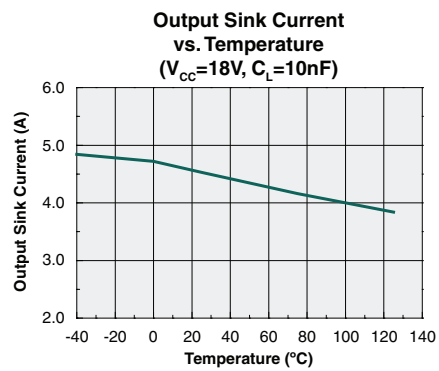
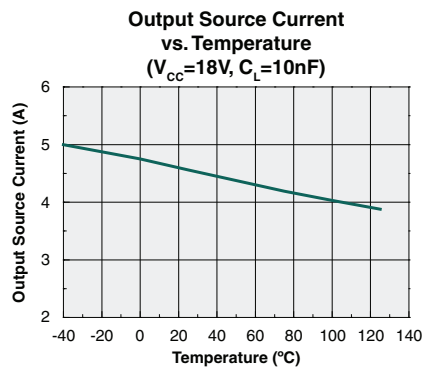

5 Manufacturing Information

5.1 Moisture Sensitivity



All plastic encapsulated semiconductor packages are susceptible to moisture ingress. IXYS Integrated Circuits Division classified all of its plastic encapsulated devices for moisture sensitivity according to the latest version of the joint industry standard, **IPC/JEDEC J-STD-020**, in force at the time of product evaluation. We test all of our products to the maximum conditions set forth in the standard, and guarantee proper operation of our devices when handled according to the limitations and information in that standard as well as to any limitations set forth in the information or standards referenced below.

Failure to adhere to the warnings or limitations as established by the listed specifications could result in reduced product performance, reduction of operable life, and/or reduction of overall reliability.

This product carries a **Moisture Sensitivity Level (MSL) rating of 1**, and should be handled according to the requirements of the latest version of the joint industry standard **IPC/JEDEC J-STD-033**.

5.2 ESD Sensitivity



This product is **ESD Sensitive**, and should be handled according to the industry standard **JESD-625**.

5.3 Reflow Profile

This product has a **maximum body temperature and time rating of 260°C for 30 seconds**. All other guidelines of **J-STD-020** must be observed.



5.4 Mechanical Dimensions

5.4.1 SIA Package (8-Pin SOIC)

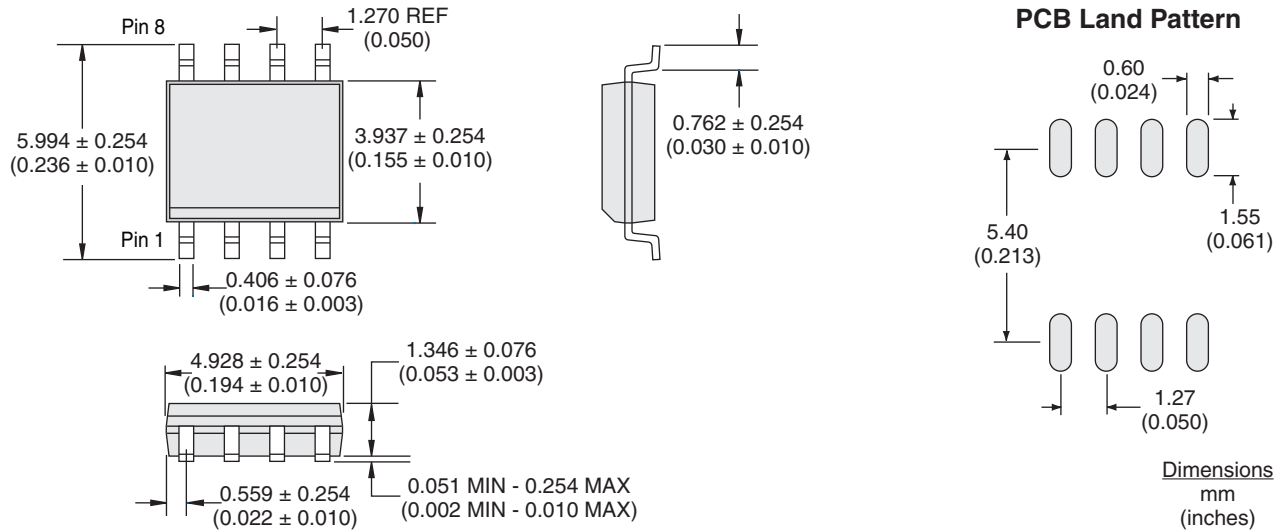

5.4.2 SI Package (8-Pin Power SOIC with Exposed Metal Back)

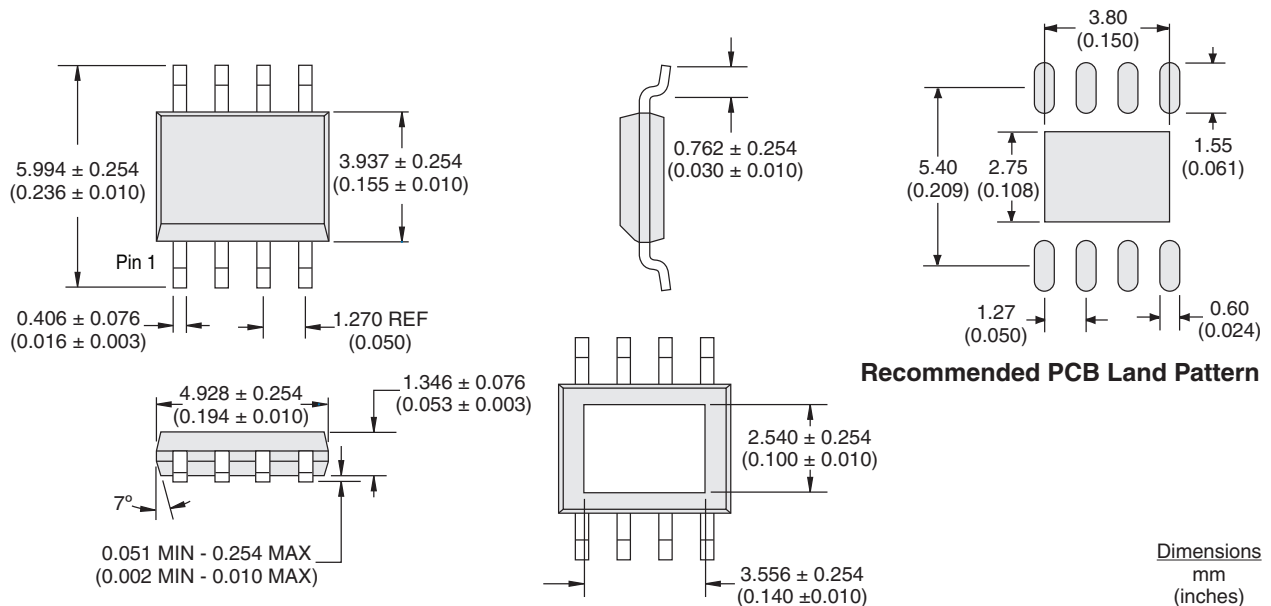

Note: The exposed metal pad on the back of the SI package should be connected to GND. It is not suitable for carrying current.

5.4.3 Tape & Reel Information for SI and SIA Packages

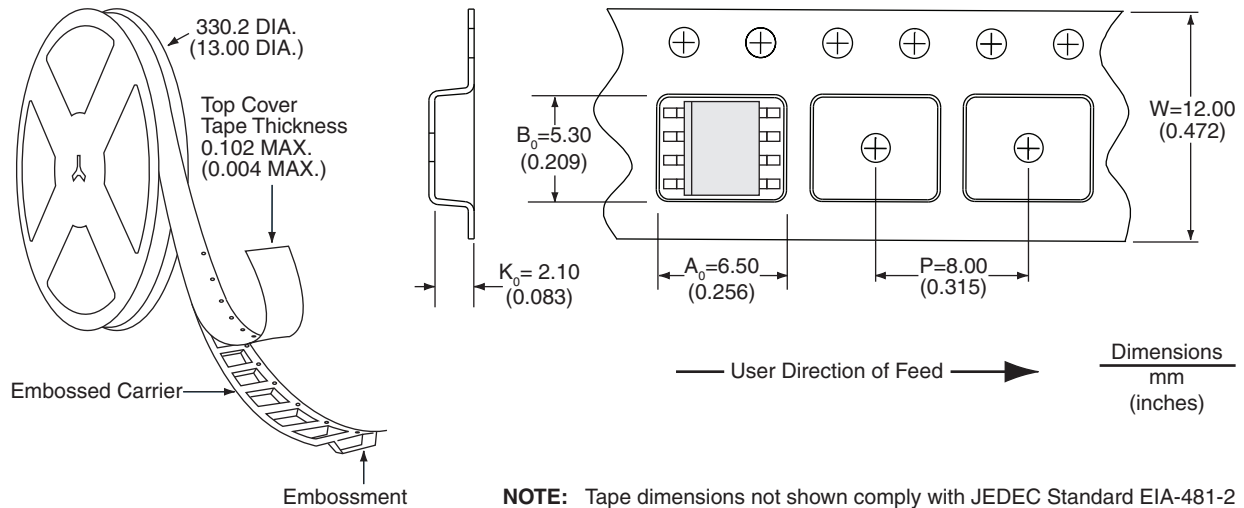

For additional information please visit our website at: www.ixysic.com

IXYS Integrated Circuits Division makes no representations or warranties with respect to the accuracy or completeness of the contents of this publication and reserves the right to make changes to specifications and product descriptions at any time without notice. Neither circuit patent licenses nor indemnity are expressed or implied. Except as set forth in IXYS Integrated Circuits Division's Standard Terms and Conditions of Sale, IXYS Integrated Circuits Division assumes no liability whatsoever, and disclaims any express or implied warranty, relating to its products including, but not limited to, the implied warranty of merchantability, fitness for a particular purpose, or infringement of any intellectual property right.

The products described in this document are not designed, intended, authorized or warranted for use as components in systems intended for surgical implant into the body, or in other applications intended to support or sustain life, or where malfunction of IXYS Integrated Circuits Division's product may result in direct physical harm, injury, or death to a person or severe property or environmental damage. IXYS Integrated Circuits Division reserves the right to discontinue or make changes to its products at any time without notice.

Specification: DS-IXD_604SI_SIA-R02
 ©Copyright 2014, IXYS Integrated Circuits Division
 All rights reserved. Printed in USA.
 6/16/2014