

# TLV5617A

## 2.7-V TO 5.5-V LOW-POWER DUAL 10-BIT DIGITAL-TO-ANALOG CONVERTER WITH POWER DOWN

SLAS234F – JULY 1999 – REVISED JULY 2002

### features

- Dual 10-Bit Voltage Output DAC
- Programmable Settling Time
  - 3  $\mu$ s in Fast Mode
  - 10  $\mu$ s in Slow Mode
- Compatible With TMS320 and SPI™ Serial Ports
- Differential Nonlinearity <0.1 LSB Typ
- Monotonic Over Temperature
- Direct Replacement for TLC5617A

### applications

- Digital Servo Control Loops
- Digital Offset and Gain Adjustment
- Industrial Process Control
- Machine and Motion Control Devices
- Mass Storage Devices

### description

The TLV5617A is a dual 10-bit voltage output DAC with a flexible 3-wire serial interface. The serial interface is compatible with TMS320, SPI™, QSPI™, and Microwire™ serial ports. It is programmed with a 16-bit serial string containing 4 control bits and 10 data bits.

The resistor string output voltage is buffered by a x2 gain rail-to-rail output buffer. The buffer features a Class-AB output stage to improve stability and reduce settling time. The programmable settling time of the DAC allows the designer to optimize speed versus power dissipation.

Implemented with a CMOS process, the device is designed for single supply operation from 2.7 V to 5.5 V. It is available in an 8-pin SOIC package in standard commercial and industrial temperature ranges.

D PACKAGE  
(TOP VIEW)

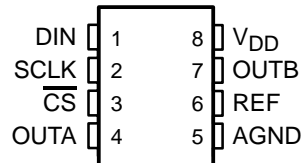

AVAILABLE OPTIONS

T <sub>A</sub>	PACKAGE
	SOIC (D)
0°C to 70°C	TLV5617ACD
–40°C to 85°C	TLV5617AID



Please be aware that an important notice concerning availability, standard warranty, and use in critical applications of Texas Instruments semiconductor products and disclaimers thereto appears at the end of this data sheet.

SPI and QSPI are trademarks of Motorola, Inc.  
Microwire is a trademark of National Semiconductor Corporation.

PRODUCTION DATA information is current as of publication date. Products conform to specifications per the terms of Texas Instruments standard warranty. Production processing does not necessarily include testing of all parameters.



POST OFFICE BOX 655303 • DALLAS, TEXAS 75265

Copyright © 2002, Texas Instruments Incorporated

**TLV5617A**  
**2.7-V TO 5.5-V LOW-POWER DUAL 10-BIT DIGITAL-TO-ANALOG**  
**CONVERTER WITH POWER DOWN**

SLAS234F – JULY 1999 – REVISED JULY 2002

**functional block diagram**

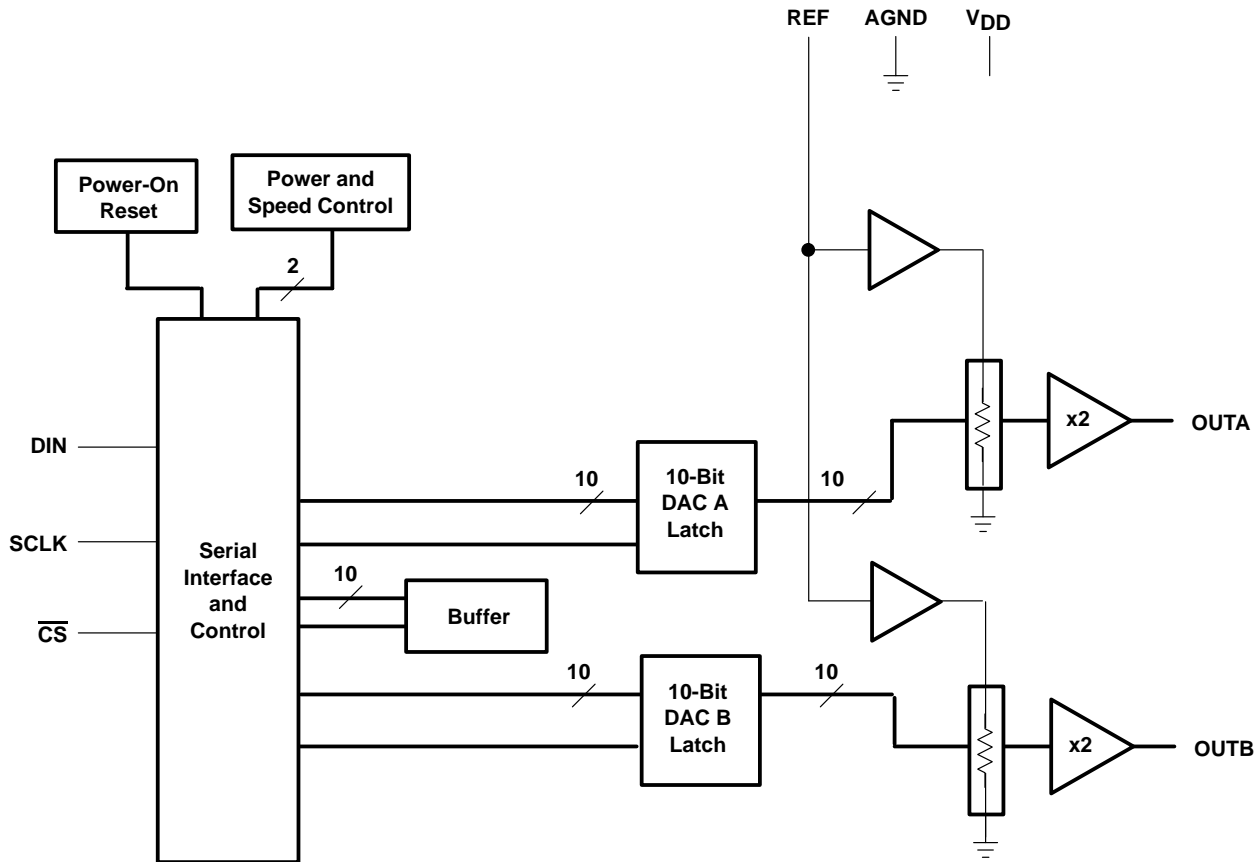

**Terminal Functions**

TERMINAL NAME	NO.	I/O/P	DESCRIPTION
AGND	5	P	Ground
$\overline{\text{CS}}$	3	I	Chip select. Digital input active low, used to enable/disable inputs.
DIN	1	I	Digital serial data input
OUTA	4	O	DAC A analog voltage output
OUTB	7	O	DAC B analog voltage output
REF	6	I	Analog reference voltage input
SCLK	2	I	Digital serial clock input
VDD	8	P	Positive power supply



**TLV5617A**  
**2.7-V TO 5.5-V LOW-POWER DUAL 10-BIT DIGITAL-TO-ANALOG**  
**CONVERTER WITH POWER DOWN**

SLAS234F – JULY 1999 – REVISED JULY 2002

**absolute maximum ratings over operating free-air temperature range (unless otherwise noted)†**

Supply voltage ( $V_{DD}$ to AGND) .....	7 V
Reference input voltage range .....	– 0.3 V to $V_{DD} + 0.3$ V
Digital input voltage range .....	– 0.3 V to $V_{DD} + 0.3$ V
Operating free-air temperature range, $T_A$ : TLV5617AC .....	0°C to 70°C
TLV5617AI .....	–40°C to 85°C
Storage temperature range, $T_{stg}$ .....	–65°C to 150°C
Lead temperature 1,6 mm (1/16 inch) from case for 10 seconds .....	260°C

† Stresses beyond those listed under “absolute maximum ratings” may cause permanent damage to the device. These are stress ratings only, and functional operation of the device at these or any other conditions beyond those indicated under “recommended operating conditions” is not implied. Exposure to absolute-maximum-rated conditions for extended periods may affect device reliability.

**recommended operating conditions**

		MIN	NOM	MAX	UNIT
Supply voltage, $V_{DD}$	$V_{DD} = 5$ V	4.5	5	5.5	V
	$V_{DD} = 3$ V	2.7	3	3.3	
Power on reset, POR		0.55		2	V
High-level digital input voltage, $V_{IH}$	$V_{DD} = 2.7$ V	2			V
	$V_{DD} = 5.5$ V	2.4			
Low-level digital input voltage, $V_{IL}$	$V_{DD} = 2.7$ V			0.6	V
	$V_{DD} = 5.5$ V			1	
Reference voltage, $V_{ref}$ to REF terminal	$V_{DD} = 5$ V (see Note 1)	AGND	2.048	$V_{DD} - 1.5$	V
	$V_{DD} = 3$ V (see Note 1)	AGND	1.024	$V_{DD} - 1.5$	
Load resistance, $R_L$		2			k $\Omega$
Load capacitance, $C_L$				100	pF
Clock frequency, $f_{CLK}$				20	MHz
Operating free-air temperature, $T_A$	TLV5617AC	0		70	°C
	TLV5617AI	–40		85	

NOTE 1: Due to the x2 output buffer, a reference input voltage  $\geq (V_{DD} - 0.4$  V)/2 causes clipping of the transfer function.



# TLV5617A

## 2.7-V TO 5.5-V LOW-POWER DUAL 10-BIT DIGITAL-TO-ANALOG CONVERTER WITH POWER DOWN

SLAS234F – JULY 1999 – REVISED JULY 2002

### electrical characteristics over recommended operating conditions (unless otherwise noted)

#### power supply

PARAMETER		TEST CONDITIONS	MIN	TYP	MAX	UNIT
I <sub>DD</sub>	Power supply current	No load, All inputs = AGND or V <sub>DD</sub> , DAC latch = 0x800	Fast	1.6	2.5	mA
			Slow	0.6	1	
	Power down supply current			1		μA
PSRR	Power supply rejection ratio	Zero scale, See Note 2		-65		dB
		Full scale, See Note 3		-65		

NOTES: 2. Power supply rejection ratio at zero scale is measured by varying V<sub>DD</sub> and is given by:

$$PSRR = 20 \log [(E_{ZS}(V_{DDmax}) - E_{ZS}(V_{DDmin})/V_{DDmax}]$$

3. Power supply rejection ratio at full scale is measured by varying V<sub>DD</sub> and is given by:

$$PSRR = 20 \log [(E_G(V_{DDmax}) - E_G(V_{DDmin})/V_{DDmax}]$$

#### static DAC specifications

PARAMETER		TEST CONDITIONS	MIN	TYP	MAX	UNIT
	Resolution		10			bits
INL	Integral nonlinearity	See Note 4		±0.7	±1	LSB
DNL	Differential nonlinearity	See Note 5		±0.1	±0.5	LSB
E <sub>ZS</sub>	Zero-scale error (offset error at zero scale)	See Note 6			±12	mV
E <sub>ZS TC</sub>	Zero-scale-error temperature coefficient	See Note 7		3		ppm/°C
E <sub>G</sub>	Gain error	See Note 8	V <sub>DD</sub> = 2.7 V to 3.3 V		±0.6	% full scale V
			V <sub>DD</sub> = 4.5 V to 5.5 V		±0.29	
E <sub>G TC</sub>	Gain-error temperature coefficient	See Note 9		1		ppm/°C

NOTES: 4. The relative accuracy of integral nonlinearity (INL), sometimes referred to as linearity error, is the maximum deviation of the output from the line between zero and full scale, excluding the effects of zero-code and full-scale errors.

5. The differential nonlinearity (DNL), sometimes referred to as differential error, is the difference between the measured and ideal 1-LSB amplitude change of any two adjacent codes.

6. Zero-scale error is the deviation from zero voltage output when the digital input code is zero.

7. Zero-scale-error temperature coefficient is given by:  $E_{ZS TC} = [E_{ZS}(T_{max}) - E_{ZS}(T_{min})]/2V_{ref} \times 10^6/(T_{max} - T_{min})$ .

8. Gain error is the deviation from the ideal output ( $2V_{ref} - 1$  LSB) with an output load of 10 kΩ.

9. Gain temperature coefficient is given by:  $E_{G TC} = [E_G(T_{max}) - E_G(T_{min})]/2V_{ref} \times 10^6/(T_{max} - T_{min})$ .

#### output specifications

PARAMETER		TEST CONDITIONS	MIN	TYP	MAX	UNIT
V <sub>O</sub>	Output voltage range	R <sub>L</sub> = 10 kΩ			V <sub>DD</sub> -0.4	V
	Output load regulation accuracy	V <sub>O</sub> = 4.096 V, 2.048 V, R <sub>L</sub> = 2 kΩ to 10 kΩ		±0.1		% FS

#### reference input

PARAMETER		TEST CONDITIONS	MIN	TYP	MAX	UNIT
V <sub>I</sub>	Input voltage range		0		V <sub>DD</sub> -1.5	V
R <sub>I</sub>	Input resistance			10		MΩ
C <sub>I</sub>	Input capacitance			5		pF
Reference input bandwidth		REF = 0.2 V <sub>pp</sub> + 1.024 V dc	Fast	1.3		MHz
			Slow	525		kHz
Reference feedthrough		REF = 1 V <sub>pp</sub> at 1 kHz + 1.024 V dc (see Note 10)		-80		dB

NOTE 10: Reference feedthrough is measured at the DAC output with an input code = 0x000.



**TLV5617A**  
**2.7-V TO 5.5-V LOW-POWER DUAL 10-BIT DIGITAL-TO-ANALOG**  
**CONVERTER WITH POWER DOWN**

SLAS234F – JULY 1999 – REVISED JULY 2002

**electrical characteristics over recommended operating conditions (unless otherwise noted)**  
**(Continued)**

**digital inputs**

PARAMETER		TEST CONDITIONS	MIN	TYP	MAX	UNIT
$I_{IH}$	High-level digital input current	$V_I = V_{DD}$			1	$\mu A$
$I_{IL}$	Low-level digital input current	$V_I = 0 V$	-1			$\mu A$
$C_i$	Input capacitance			8		pF

**analog output dynamic performance**

PARAMETER		TEST CONDITIONS		MIN	TYP	MAX	UNIT
$t_{s(FS)}$	Output settling time, full scale	$R_L = 10 k\Omega$ , $C_L = 100 pF$ , See Note 11	Fast		1	3	$\mu s$
			Slow		3	10	
$t_{s(CC)}$	Output settling time, code to code	$R_L = 10 k\Omega$ , $C_L = 100 pF$ , See Note 12	Fast		1		$\mu s$
			Slow		2		
SR	Slew rate	$R_L = 10 k\Omega$ , $C_L = 100 pF$ , See Note 13	Fast		3		V/ $\mu s$
			Slow		0.5		
Glitch energy		DIN = 0 to 1, FCLK = 100 kHz, $\overline{CS} = V_{DD}$			5		nV-s
SNR	Signal-to-noise ratio	$f_s = 102 kSPS$ , $f_{out} = 1 kHz$ , $R_L = 10 k\Omega$ , $C_L = 100 pF$			68		dB
SINAD	Signal-to-noise + distortion				65		
THD	Total harmonic distortion				-62		
SFDR	Spurious free dynamic range				64		

- NOTES: 11. Settling time is the time for the output signal to remain within  $\pm 0.5$  LSB of the final measured value for a digital input code change of 0x020 to 0xFDC and 0xFDC to 0x020 respectively. Not tested, assured by design.  
12. Settling time is the time for the output signal to remain within  $\pm 0.5$  LSB of the final measured value for a digital input code change of one count. Not tested, assured by design.  
13. Slew rate determines the time it takes for a change of the DAC output from 10% to 90% of full-scale voltage.

**TLV5617A**  
**2.7-V TO 5.5-V LOW-POWER DUAL 10-BIT DIGITAL-TO-ANALOG**  
**CONVERTER WITH POWER DOWN**

SLAS234F – JULY 1999 – REVISED JULY 2002

**digital input timing requirements**

		MIN	NOM	MAX	UNIT
$t_{su}(CS-CK)$	Setup time, $\overline{CS}$ low before first negative SCLK edge	$V_{DD} = 2.7\text{ V to }3.3\text{ V}$	10		ns
		$V_{DD} = 4.5\text{ V to }5.5\text{ V}$	5		
$t_{su}(C16-CS)$	Setup time, 16 <sup>th</sup> negative SCLK edge before $\overline{CS}$ rising edge	10			ns
$t_{wH}$	SCLK pulse width high	25			ns
$t_{wL}$	SCLK pulse width low	25			ns
$t_{su}(D)$	Setup time, data ready before SCLK falling edge	$V_{DD} = 2.7\text{ V to }3.3\text{ V}$	10		ns
		$V_{DD} = 4.5\text{ V to }5.5\text{ V}$	5		
$t_h(D)$	Hold time, data held valid after SCLK falling edge	$V_{DD} = 2.7\text{ V to }3.3\text{ V}$	10		ns
		$V_{DD} = 4.5\text{ V to }5.5\text{ V}$	5		

**timing requirements**

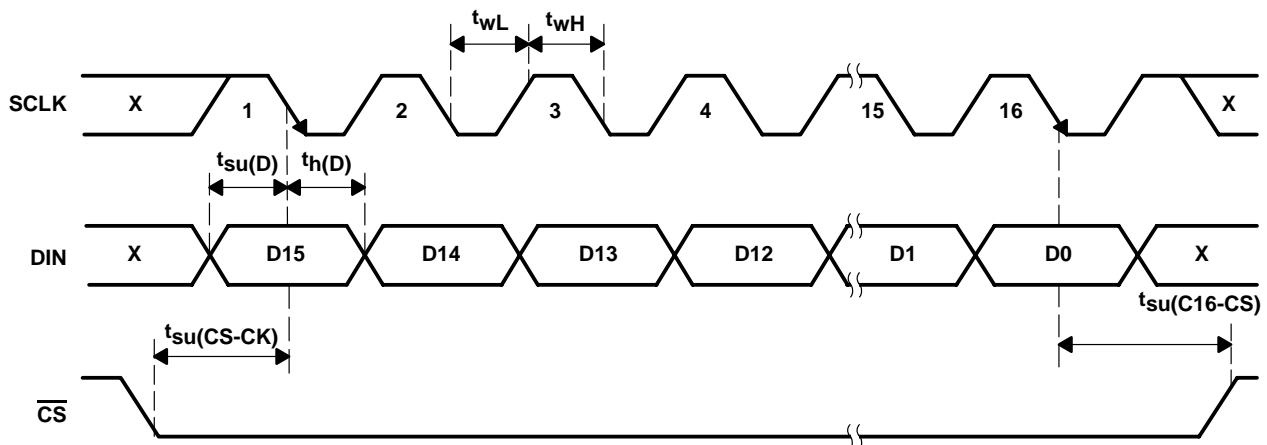

**Figure 1. Timing Diagram**

# TLV5617A

## 2.7-V TO 5.5-V LOW-POWER DUAL 10-BIT DIGITAL-TO-ANALOG CONVERTER WITH POWER DOWN

SLAS234F – JULY 1999 – REVISED JULY 2002

### TYPICAL CHARACTERISTICS

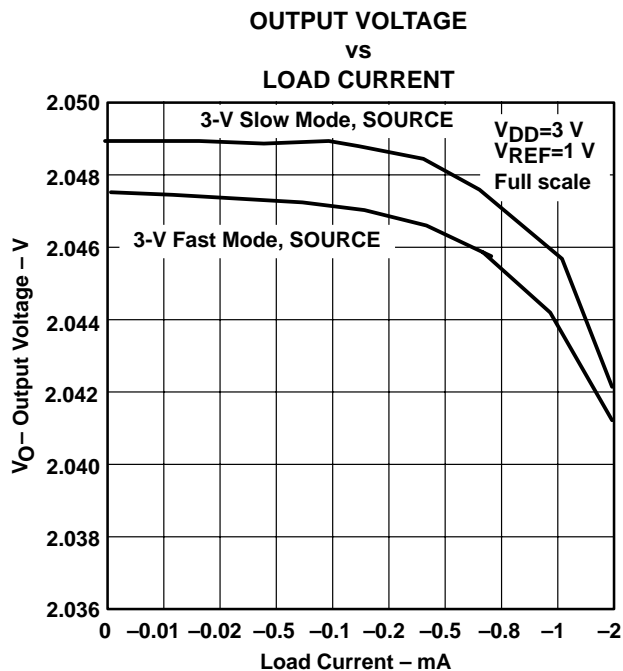

Figure 2

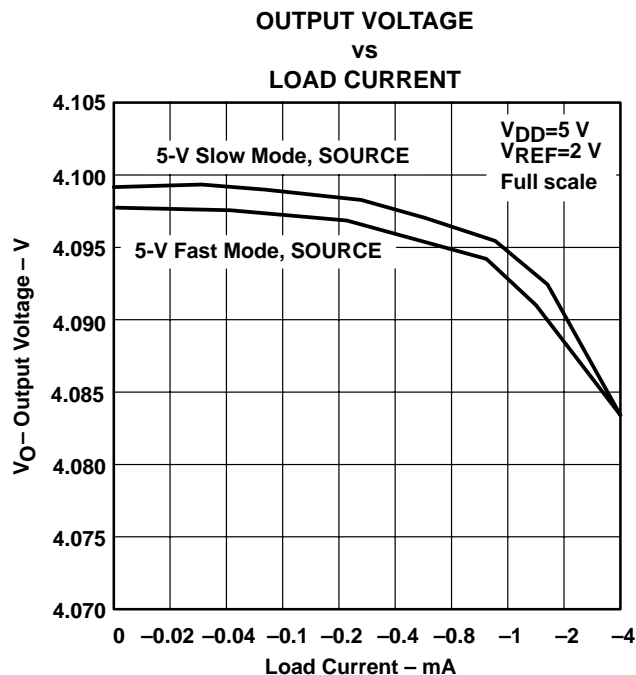

Figure 3

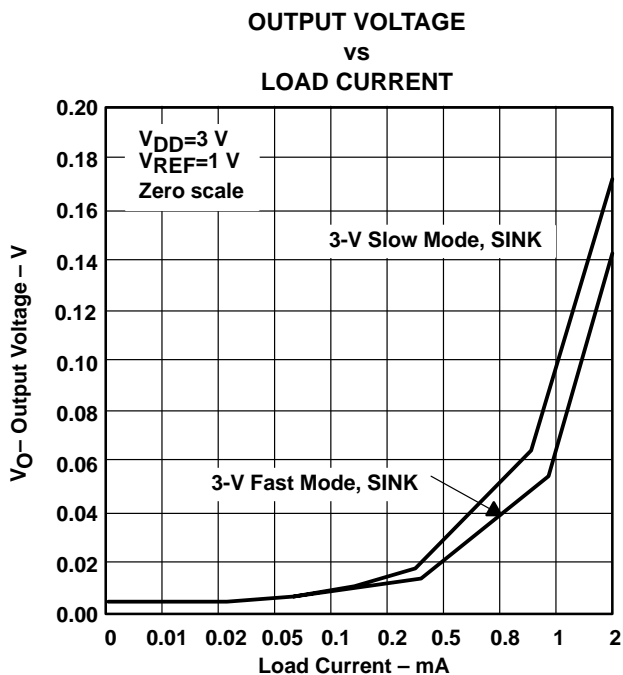

Figure 4

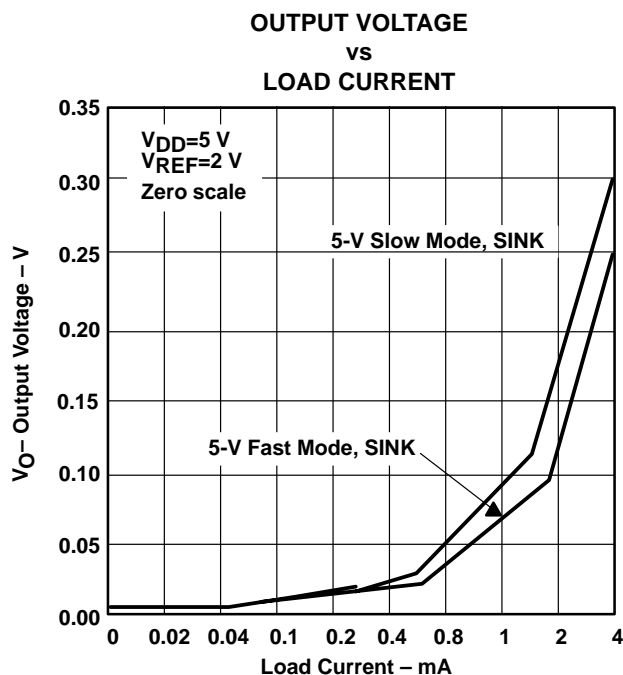

Figure 5

**TLV5617A**  
**2.7-V TO 5.5-V LOW-POWER DUAL 10-BIT DIGITAL-TO-ANALOG**  
**CONVERTER WITH POWER DOWN**

SLAS234F – JULY 1999 – REVISED JULY 2002

**TYPICAL CHARACTERISTICS**

**SUPPLY CURRENT**  
**vs**  
**FREE-AIR TEMPERATURE**

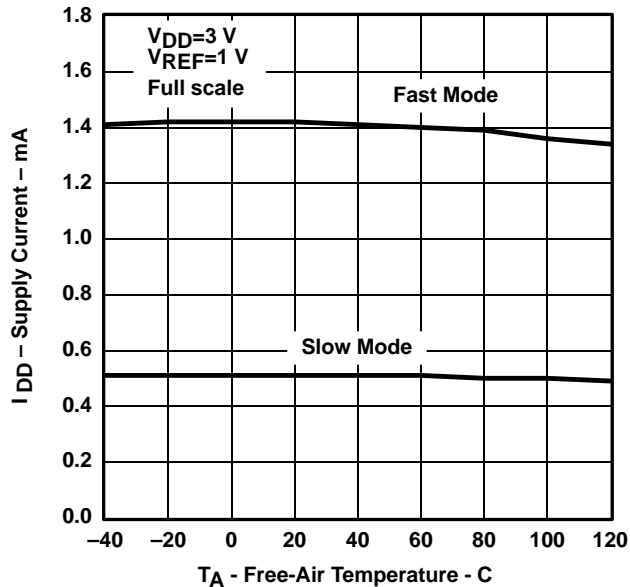

**Figure 6**

**SUPPLY CURRENT**  
**vs**  
**FREE-AIR TEMPERATURE**

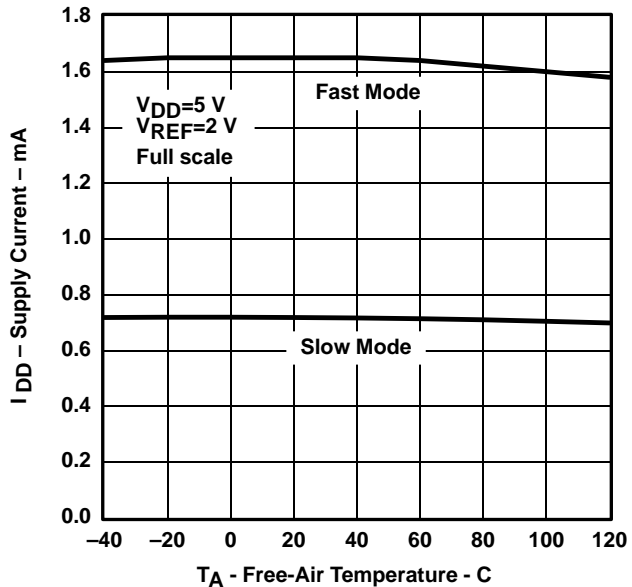

**Figure 7**

**TOTAL HARMONIC DISTORTION**  
**vs**  
**FREQUENCY**

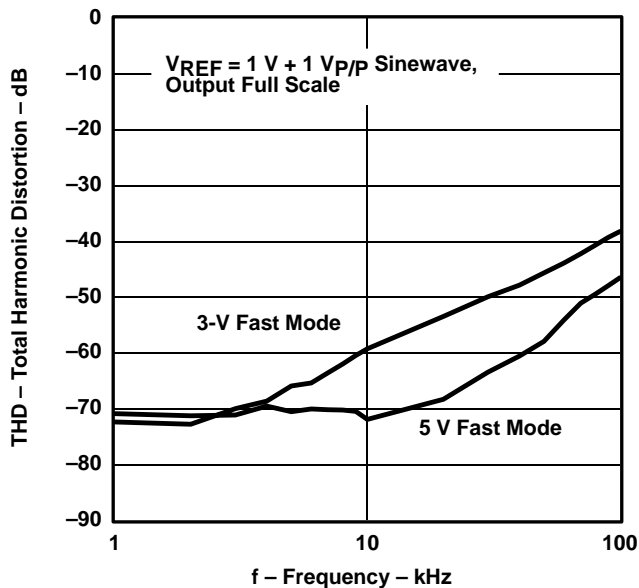

**Figure 8**

**TOTAL HARMONIC DISTORTION**  
**vs**  
**FREQUENCY**

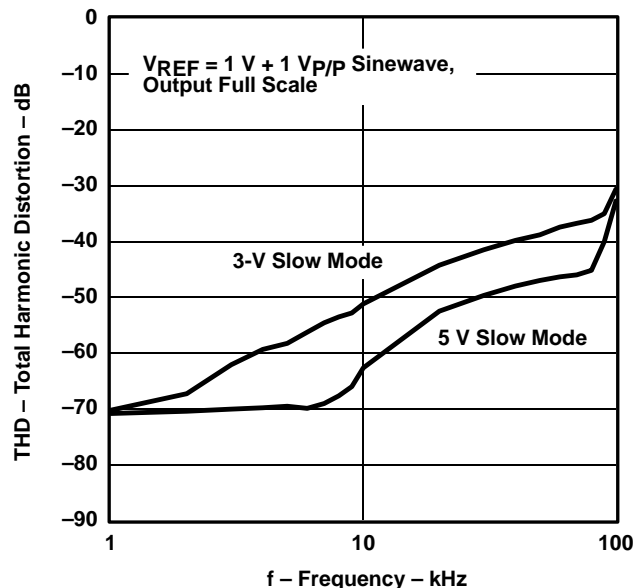

**Figure 9**





TYPICAL CHARACTERISTICS

INTEGRAL NONLINEARITY ERROR  
vs  
DIGITAL CODE

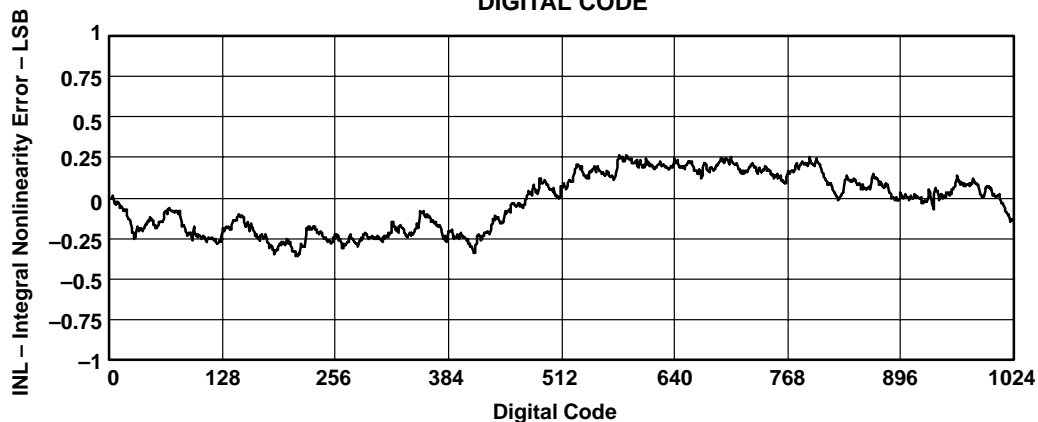

Figure 10

DIFFERENTIAL NONLINEARITY ERROR  
vs  
DIGITAL CODE

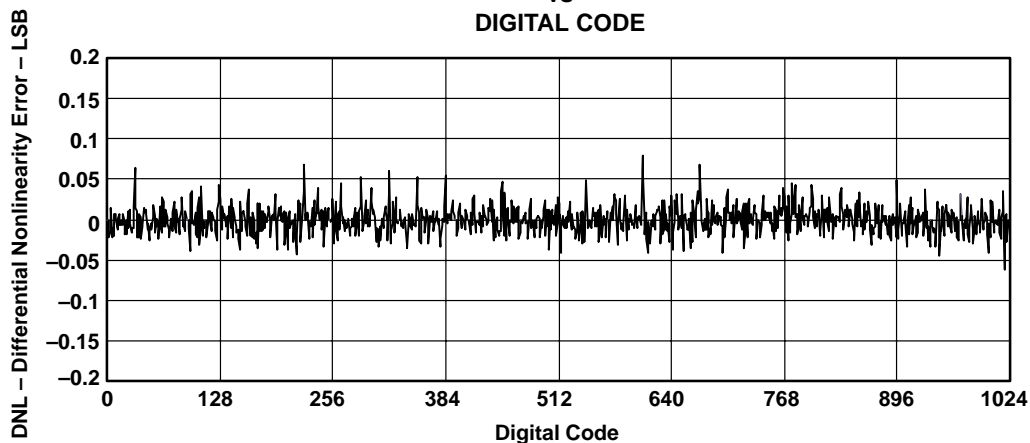

Figure 11

# TLV5617A

## 2.7-V TO 5.5-V LOW-POWER DUAL 10-BIT DIGITAL-TO-ANALOG CONVERTER WITH POWER DOWN

SLAS234F – JULY 1999 – REVISED JULY 2002

### APPLICATION INFORMATION

#### general function

The TLV5617A is a dual 10-bit, single-supply DAC, based on a resistor-string architecture. It consists of a serial interface, speed and power-down control logic, a resistor string, and a rail-to-rail output buffer.

The output voltage (full scale determined by the reference) is given by:

$$2 \text{ REF } \frac{\text{CODE}}{2^n} \text{ [V]}$$

Where REF is the reference voltage and CODE is the digital input value within the range of  $0_{10}$  to  $2^n-1$ , where  $n=10$  (bits). The 16-bit data word, consisting of control bits and the new DAC value, is illustrated in the *data format* section. A power-on reset initially resets the internal latches to a defined state (all bits zero).

#### serial interface

A falling edge of  $\overline{\text{CS}}$  starts shifting the data bit-per-bit (starting with the MSB) to the internal register on the falling edges of SCLK. After 16 bits have been transferred or  $\overline{\text{CS}}$  rises, the content of the shift register is moved to the target latches (DAC A, DAC B, BUFFER, CONTROL), depending on the control bits within the data word.

Figure 12 shows examples of how to connect the TLV5617A to TMS320, SPI, and Microwire.

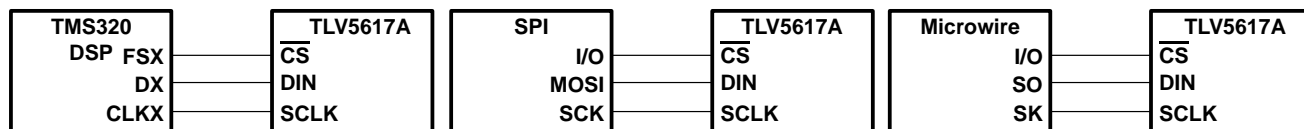

Figure 12. Three-Wire Interface

Notes on SPI and Microwire: Before the controller starts the data transfer, the software has to generate a falling edge on the pin connected to  $\overline{\text{CS}}$ . If the word width is 8 bits (SPI and Microwire) two write operations must be performed to program the TLV5617A. After the write operation(s), the holding registers or the control register of the DAC update automatically on the rising  $\overline{\text{CS}}$  edge, ending the write cycle to the DAC. Note: After transfer of the LSB during a data or control write cycle, one additional rising edge on SCLK is required to reset the internal state machine. This edge can occur when  $\overline{\text{CS}}$  is high or low, but must occur before the next falling  $\overline{\text{CS}}$  edge that begins the following write cycle. Refer to the timing diagram for more information.

#### serial clock frequency and update rate

The maximum serial clock frequency is given by:

$$f_{\text{sclkmax}} = \frac{1}{t_{\text{whmin}} + t_{\text{wlmin}}} = 20 \text{ MHz}$$

The maximum update rate is:

$$f_{\text{updatemax}} = \frac{1}{16(t_{\text{whmin}} + t_{\text{wlmin}})} = 1.25 \text{ MHz}$$

Note that the maximum update rate is just a theoretical value for the serial interface, as the settling time of the TLV5617A should also be considered.



**TLV5617A**  
**2.7-V TO 5.5-V LOW-POWER DUAL 10-BIT DIGITAL-TO-ANALOG**  
**CONVERTER WITH POWER DOWN**

SLAS234F – JULY 1999 – REVISED JULY 2002

**APPLICATION INFORMATION**

**examples of operation (continued)**

Both outputs are updated on the rising clock edge after D0 from the DAC A data word is sampled.

- Set powerdown mode:

D15	D14	D13	D12	D11	D10	D9	D8	D7	D6	D5	D4	D3	D2	D1	D0
X	X	1	X	X	X	X	X	X	X	X	X	X	X	X	X

X = Don't care

**linearity, offset, and gain error using single ended supplies**

When an amplifier is operated from a single supply, the voltage offset can still be either positive or negative. With a positive offset, the output voltage changes on the first code change. With a negative offset, the output voltage may not change with the first code, depending on the magnitude of the offset voltage.

The output amplifier attempts to drive the output to a negative voltage. However, because the most negative supply rail is ground, the output cannot drive below ground and clamps the output at 0 V.

The output voltage then remains at zero until the input code value produces a sufficient positive output voltage to overcome the negative offset voltage, resulting in the transfer function shown in Figure 13.

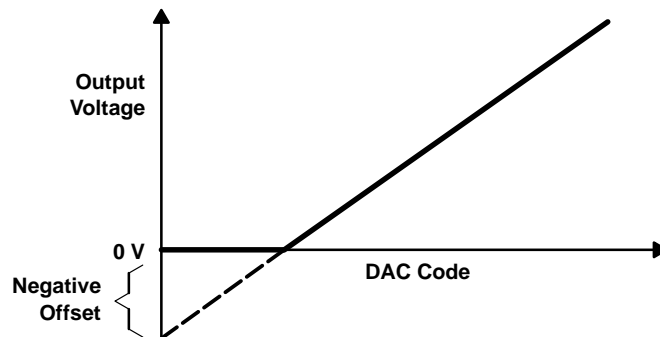

**Figure 13. Effect of Negative Offset (Single Supply)**

This offset error, not the linearity error, produces this breakpoint. The transfer function would have followed the dotted line if the output buffer could drive below the ground rail.

For a DAC, linearity is measured between zero-input code (all inputs 0) and full-scale code (all inputs 1) after offset and full scale are adjusted out or accounted for in some way. However, single supply operation does not allow for adjustment when the offset is negative due to the breakpoint in the transfer function. So the linearity is measured between full-scale code and the lowest code that produces a positive output voltage.

**definitions of specifications and terminology**

**integral nonlinearity (INL)**

The relative accuracy or integral nonlinearity (INL), sometimes referred to as linearity error, is the maximum deviation of the output from the line between zero and full scale excluding the effects of zero code and full-scale errors.

**differential nonlinearity (DNL)**

The differential nonlinearity (DNL), sometimes referred to as differential error, is the difference between the measured and ideal 1 LSB amplitude change of any two adjacent codes. Monotonic means the output voltage changes in the same direction (or remains constant) as a change in the digital input code.



**definitions of specifications and terminology (continued)**

**zero-scale error ( $E_{ZS}$ )**

Zero-scale error is defined as the deviation of the output from 0 V at a digital input value of 0.

**gain error ( $E_G$ )**

Gain error is the error in slope of the DAC transfer function.

**total harmonic distortion (THD)**

THD is the ratio of the rms value of the first six harmonic components to the value of the fundamental signal. The value for THD is expressed in decibels.

**signal-to-noise ratio + distortion (S/N+D)**

S/N+D is the ratio of the rms value of the output signal to the rms sum of all other spectral components below the Nyquist frequency, including harmonics but excluding dc. The value for S/N+D is expressed in decibels.

**spurious free dynamic range (SFDR)**

Spurious free dynamic range is the difference between the rms value of the output signal and the rms value of the largest spurious signal within a specified bandwidth. The value for SFDR is expressed in decibels.

**PACKAGING INFORMATION**

Orderable Device	Status (1)	Package Type	Package Drawing	Pins	Package Qty	Eco Plan (2)	Lead/Ball Finish	MSL Peak Temp (3)	Op Temp (°C)	Device Marking (4/5)	Samples
TLV5617ACD	ACTIVE	SOIC	D	8	75	Green (RoHS & no Sb/Br)	CU NIPDAU	Level-1-260C-UNLIM	0 to 70	TV5617	<a href="#">Samples</a>
TLV5617ACDG4	ACTIVE	SOIC	D	8	75	Green (RoHS & no Sb/Br)	CU NIPDAU	Level-1-260C-UNLIM	0 to 70	TV5617	<a href="#">Samples</a>
TLV5617ACDR	ACTIVE	SOIC	D	8	2500	Green (RoHS & no Sb/Br)	CU NIPDAU	Level-1-260C-UNLIM	0 to 70	TV5617	<a href="#">Samples</a>
TLV5617ACDRG4	ACTIVE	SOIC	D	8	2500	Green (RoHS & no Sb/Br)	CU NIPDAU	Level-1-260C-UNLIM	0 to 70	TV5617	<a href="#">Samples</a>
TLV5617AID	ACTIVE	SOIC	D	8	75	Green (RoHS & no Sb/Br)	CU NIPDAU	Level-1-260C-UNLIM	-40 to 85	TY5617	<a href="#">Samples</a>
TLV5617AIDG4	ACTIVE	SOIC	D	8	75	Green (RoHS & no Sb/Br)	CU NIPDAU	Level-1-260C-UNLIM	-40 to 85	TY5617	<a href="#">Samples</a>
TLV5617AIDR	ACTIVE	SOIC	D	8	2500	Green (RoHS & no Sb/Br)	CU NIPDAU	Level-1-260C-UNLIM	-40 to 85	TY5617	<a href="#">Samples</a>
TLV5617AIDRG4	ACTIVE	SOIC	D	8	2500	Green (RoHS & no Sb/Br)	CU NIPDAU	Level-1-260C-UNLIM	-40 to 85	TY5617	<a href="#">Samples</a>

(1) The marketing status values are defined as follows:

**ACTIVE:** Product device recommended for new designs.

**LIFEBUY:** TI has announced that the device will be discontinued, and a lifetime-buy period is in effect.

**NRND:** Not recommended for new designs. Device is in production to support existing customers, but TI does not recommend using this part in a new design.

**PREVIEW:** Device has been announced but is not in production. Samples may or may not be available.

**OBSOLETE:** TI has discontinued the production of the device.

(2) Eco Plan - The planned eco-friendly classification: Pb-Free (RoHS), Pb-Free (RoHS Exempt), or Green (RoHS & no Sb/Br) - please check <http://www.ti.com/productcontent> for the latest availability information and additional product content details.

**TBD:** The Pb-Free/Green conversion plan has not been defined.

**Pb-Free (RoHS):** TI's terms "Lead-Free" or "Pb-Free" mean semiconductor products that are compatible with the current RoHS requirements for all 6 substances, including the requirement that lead not exceed 0.1% by weight in homogeneous materials. Where designed to be soldered at high temperatures, TI Pb-Free products are suitable for use in specified lead-free processes.

**Pb-Free (RoHS Exempt):** This component has a RoHS exemption for either 1) lead-based flip-chip solder bumps used between the die and package, or 2) lead-based die adhesive used between the die and leadframe. The component is otherwise considered Pb-Free (RoHS compatible) as defined above.

**Green (RoHS & no Sb/Br):** TI defines "Green" to mean Pb-Free (RoHS compatible), and free of Bromine (Br) and Antimony (Sb) based flame retardants (Br or Sb do not exceed 0.1% by weight in homogeneous material)

(3) MSL, Peak Temp. -- The Moisture Sensitivity Level rating according to the JEDEC industry standard classifications, and peak solder temperature.

(4) There may be additional marking, which relates to the logo, the lot trace code information, or the environmental category on the device.

(5) Multiple Device Markings will be inside parentheses. Only one Device Marking contained in parentheses and separated by a "~" will appear on a device. If a line is indented then it is a continuation of the previous line and the two combined represent the entire Device Marking for that device.

**Important Information and Disclaimer:** The information provided on this page represents TI's knowledge and belief as of the date that it is provided. TI bases its knowledge and belief on information provided by third parties, and makes no representation or warranty as to the accuracy of such information. Efforts are underway to better integrate information from third parties. TI has taken and continues to take reasonable steps to provide representative and accurate information but may not have conducted destructive testing or chemical analysis on incoming materials and chemicals. TI and TI suppliers consider certain information to be proprietary, and thus CAS numbers and other limited information may not be available for release.

In no event shall TI's liability arising out of such information exceed the total purchase price of the TI part(s) at issue in this document sold by TI to Customer on an annual basis.

## TAPE AND REEL INFORMATION



### QUADRANT ASSIGNMENTS FOR PIN 1 ORIENTATION IN TAPE



\*All dimensions are nominal

Device	Package Type	Package Drawing	Pins	SPQ	Reel Diameter (mm)	Reel Width W1 (mm)	A0 (mm)	B0 (mm)	K0 (mm)	P1 (mm)	W (mm)	Pin1 Quadrant
TLV5617AIDR	SOIC	D	8	2500	330.0	12.4	6.4	5.2	2.1	8.0	12.0	Q1



**TAPE AND REEL BOX DIMENSIONS**



\*All dimensions are nominal

Device	Package Type	Package Drawing	Pins	SPQ	Length (mm)	Width (mm)	Height (mm)
TLV5617AIDR	SOIC	D	8	2500	367.0	367.0	35.0

D (R-PDSO-G8)

PLASTIC SMALL OUTLINE



- NOTES:
- A. All linear dimensions are in inches (millimeters).
  - B. This drawing is subject to change without notice.
  - C. Body length does not include mold flash, protrusions, or gate burrs. Mold flash, protrusions, or gate burrs shall not exceed 0.006 (0,15) each side.
  - D. Body width does not include interlead flash. Interlead flash shall not exceed 0.017 (0,43) each side.
  - E. Reference JEDEC MS-012 variation AA.

D (R-PDSO-G8)

PLASTIC SMALL OUTLINE



- NOTES:
- All linear dimensions are in millimeters.
  - This drawing is subject to change without notice.
  - Publication IPC-7351 is recommended for alternate designs.
  - Laser cutting apertures with trapezoidal walls and also rounding corners will offer better paste release. Customers should contact their board assembly site for stencil design recommendations. Refer to IPC-7525 for other stencil recommendations.
  - Customers should contact their board fabrication site for solder mask tolerances between and around signal pads.

## IMPORTANT NOTICE

Texas Instruments Incorporated and its subsidiaries (TI) reserve the right to make corrections, enhancements, improvements and other changes to its semiconductor products and services per JESD46, latest issue, and to discontinue any product or service per JESD48, latest issue. Buyers should obtain the latest relevant information before placing orders and should verify that such information is current and complete. All semiconductor products (also referred to herein as "components") are sold subject to TI's terms and conditions of sale supplied at the time of order acknowledgment.

TI warrants performance of its components to the specifications applicable at the time of sale, in accordance with the warranty in TI's terms and conditions of sale of semiconductor products. Testing and other quality control techniques are used to the extent TI deems necessary to support this warranty. Except where mandated by applicable law, testing of all parameters of each component is not necessarily performed.

TI assumes no liability for applications assistance or the design of Buyers' products. Buyers are responsible for their products and applications using TI components. To minimize the risks associated with Buyers' products and applications, Buyers should provide adequate design and operating safeguards.

TI does not warrant or represent that any license, either express or implied, is granted under any patent right, copyright, mask work right, or other intellectual property right relating to any combination, machine, or process in which TI components or services are used. Information published by TI regarding third-party products or services does not constitute a license to use such products or services or a warranty or endorsement thereof. Use of such information may require a license from a third party under the patents or other intellectual property of the third party, or a license from TI under the patents or other intellectual property of TI.

Reproduction of significant portions of TI information in TI data books or data sheets is permissible only if reproduction is without alteration and is accompanied by all associated warranties, conditions, limitations, and notices. TI is not responsible or liable for such altered documentation. Information of third parties may be subject to additional restrictions.

Resale of TI components or services with statements different from or beyond the parameters stated by TI for that component or service voids all express and any implied warranties for the associated TI component or service and is an unfair and deceptive business practice. TI is not responsible or liable for any such statements.

Buyer acknowledges and agrees that it is solely responsible for compliance with all legal, regulatory and safety-related requirements concerning its products, and any use of TI components in its applications, notwithstanding any applications-related information or support that may be provided by TI. Buyer represents and agrees that it has all the necessary expertise to create and implement safeguards which anticipate dangerous consequences of failures, monitor failures and their consequences, lessen the likelihood of failures that might cause harm and take appropriate remedial actions. Buyer will fully indemnify TI and its representatives against any damages arising out of the use of any TI components in safety-critical applications.

In some cases, TI components may be promoted specifically to facilitate safety-related applications. With such components, TI's goal is to help enable customers to design and create their own end-product solutions that meet applicable functional safety standards and requirements. Nonetheless, such components are subject to these terms.

No TI components are authorized for use in FDA Class III (or similar life-critical medical equipment) unless authorized officers of the parties have executed a special agreement specifically governing such use.

Only those TI components which TI has specifically designated as military grade or "enhanced plastic" are designed and intended for use in military/aerospace applications or environments. Buyer acknowledges and agrees that any military or aerospace use of TI components which have **not** been so designated is solely at the Buyer's risk, and that Buyer is solely responsible for compliance with all legal and regulatory requirements in connection with such use.

TI has specifically designated certain components as meeting ISO/TS16949 requirements, mainly for automotive use. In any case of use of non-designated products, TI will not be responsible for any failure to meet ISO/TS16949.

### Products

Audio	<a href="http://www.ti.com/audio">www.ti.com/audio</a>
Amplifiers	<a href="http://amplifier.ti.com">amplifier.ti.com</a>
Data Converters	<a href="http://dataconverter.ti.com">dataconverter.ti.com</a>
DLP® Products	<a href="http://www.dlp.com">www.dlp.com</a>
DSP	<a href="http://dsp.ti.com">dsp.ti.com</a>
Clocks and Timers	<a href="http://www.ti.com/clocks">www.ti.com/clocks</a>
Interface	<a href="http://interface.ti.com">interface.ti.com</a>
Logic	<a href="http://logic.ti.com">logic.ti.com</a>
Power Mgmt	<a href="http://power.ti.com">power.ti.com</a>
Microcontrollers	<a href="http://microcontroller.ti.com">microcontroller.ti.com</a>
RFID	<a href="http://www.ti-rfid.com">www.ti-rfid.com</a>
OMAP Applications Processors	<a href="http://www.ti.com/omap">www.ti.com/omap</a>
Wireless Connectivity	<a href="http://www.ti.com/wirelessconnectivity">www.ti.com/wirelessconnectivity</a>

### Applications

Automotive and Transportation	<a href="http://www.ti.com/automotive">www.ti.com/automotive</a>
Communications and Telecom	<a href="http://www.ti.com/communications">www.ti.com/communications</a>
Computers and Peripherals	<a href="http://www.ti.com/computers">www.ti.com/computers</a>
Consumer Electronics	<a href="http://www.ti.com/consumer-apps">www.ti.com/consumer-apps</a>
Energy and Lighting	<a href="http://www.ti.com/energy">www.ti.com/energy</a>
Industrial	<a href="http://www.ti.com/industrial">www.ti.com/industrial</a>
Medical	<a href="http://www.ti.com/medical">www.ti.com/medical</a>
Security	<a href="http://www.ti.com/security">www.ti.com/security</a>
Space, Avionics and Defense	<a href="http://www.ti.com/space-avionics-defense">www.ti.com/space-avionics-defense</a>
Video and Imaging	<a href="http://www.ti.com/video">www.ti.com/video</a>

### TI E2E Community

[e2e.ti.com](http://e2e.ti.com)